

bee fix

BEEFIXTECH.COM



NG25WR

NG25
Series



MANUALE
HYDRAULIC COIL CONNECTIONS

IDRAULICHE ABS

KIT BOBINE

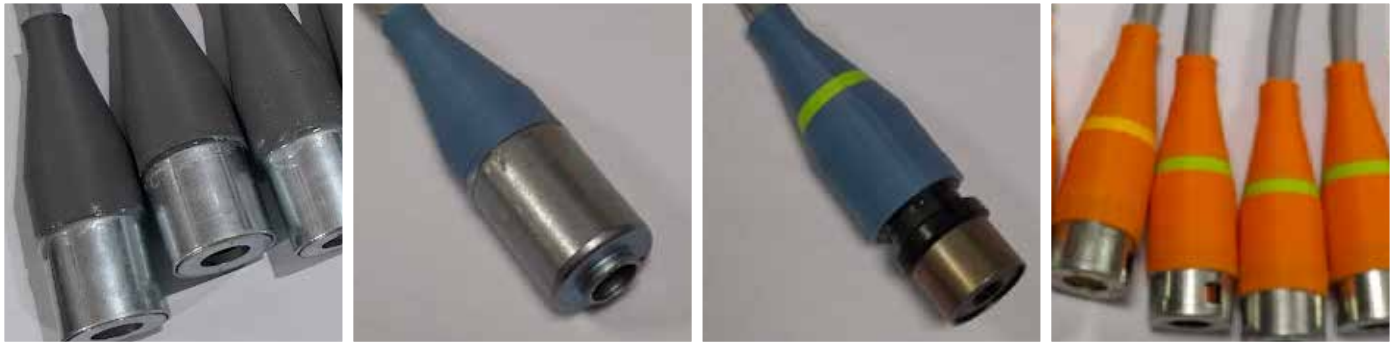

KT1	KT2	KT4	KT3
BOSCH	ATE MK-MANDO	ATE MK60 (PICCOLE)	ATE MK100
BOSCH 8.0	MK60	MK60	MK100
BOSCH 8.1	MK61		
BOSCH 9.0	MK20		
BOSCH 9.1	MK25		
BOSCH SBC	MANDO 1		
MOBIS 1	MANDO 2		
MOBIS 2	MANDO 3		
MOBIS 3	MANDO 4		
MANDO 6	MANDO 5		

KIT MOTORE





CARS

PG. 3





PG. 4

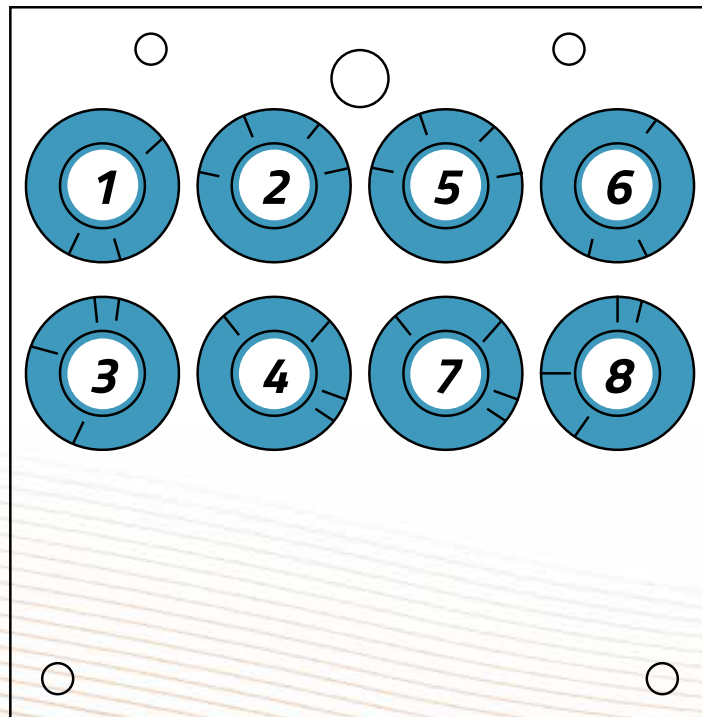
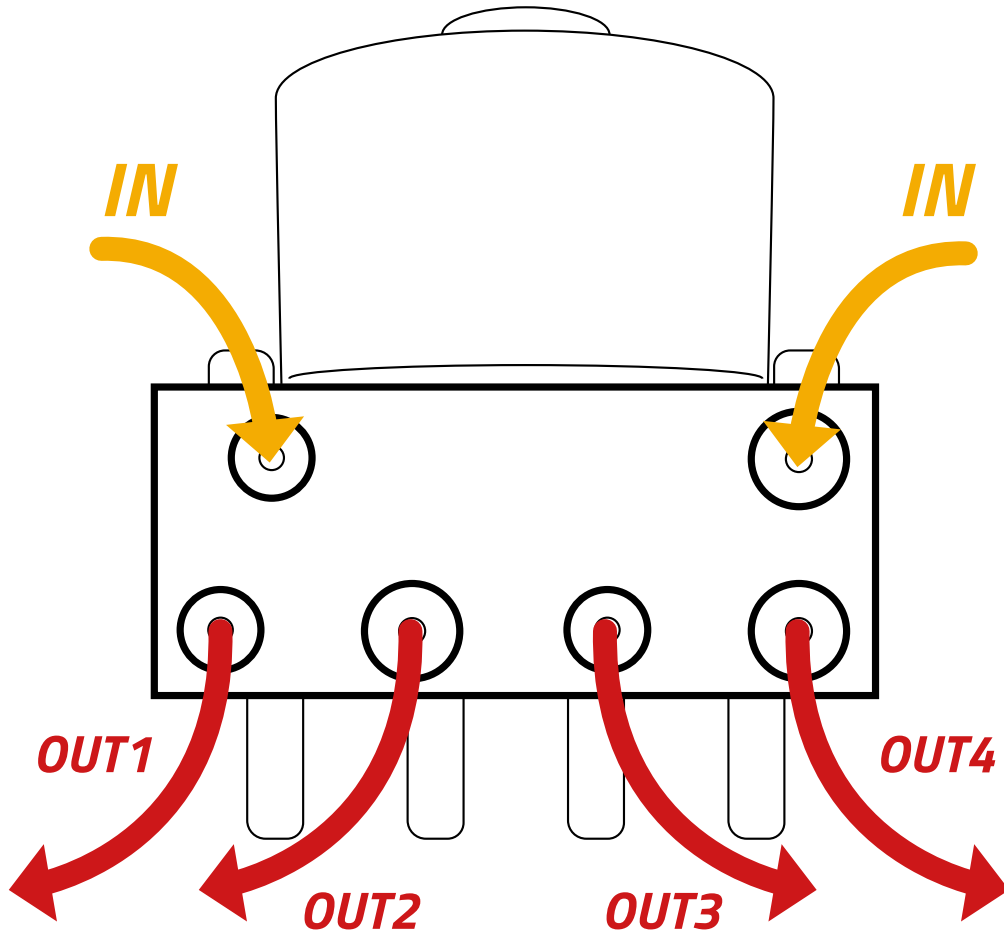



PG. 5

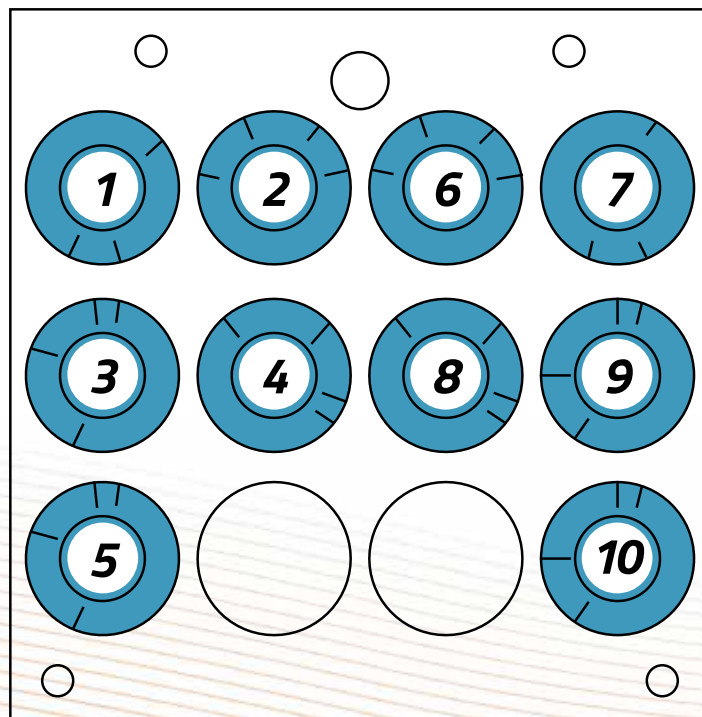
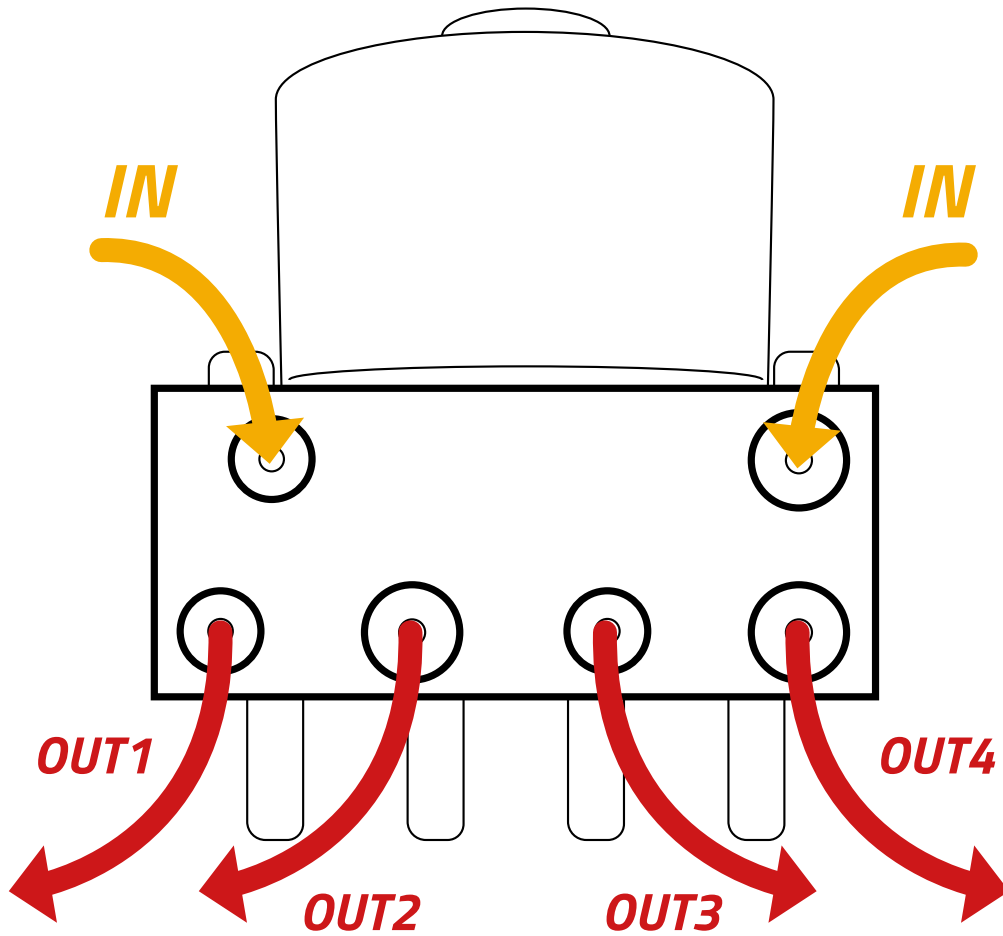

PG. 6

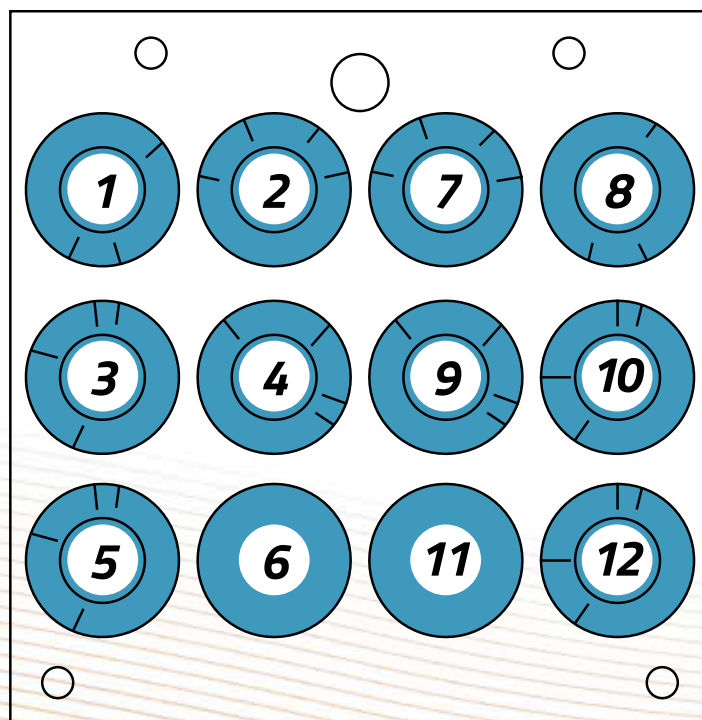
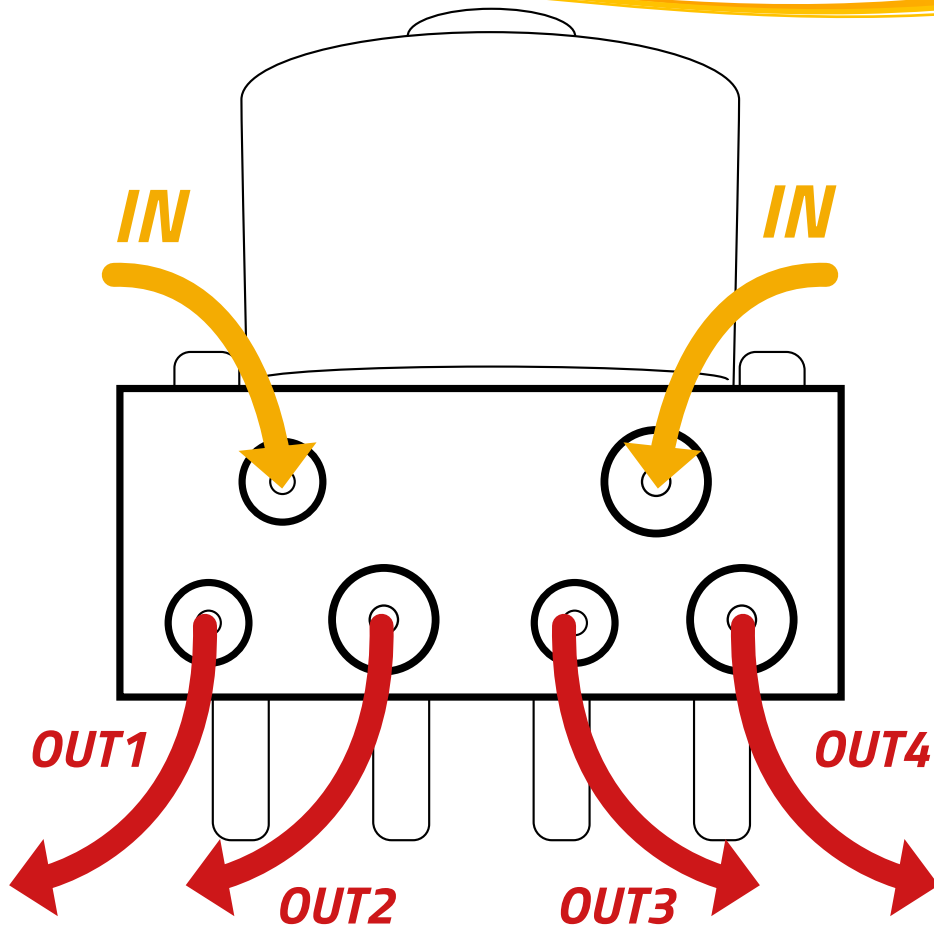



PG. 7

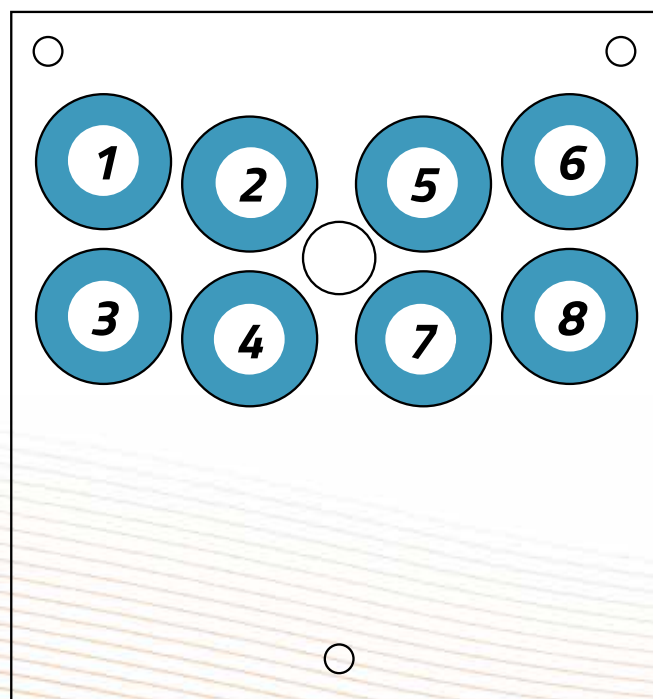
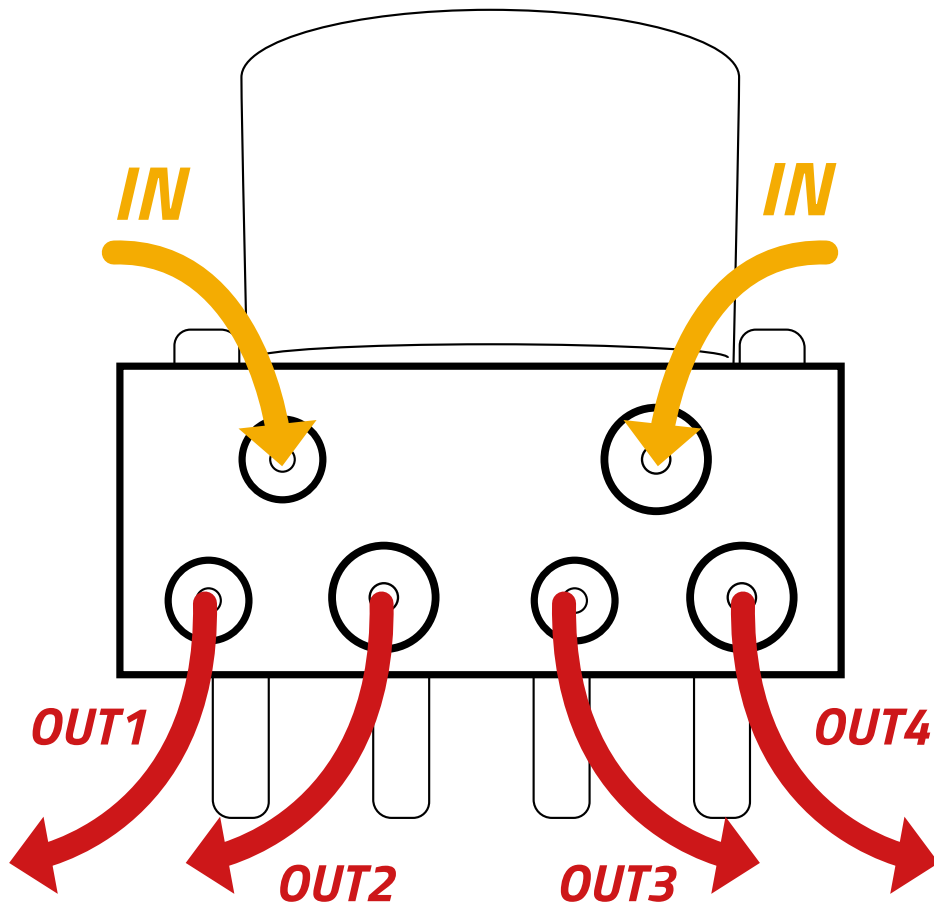

PG. 8

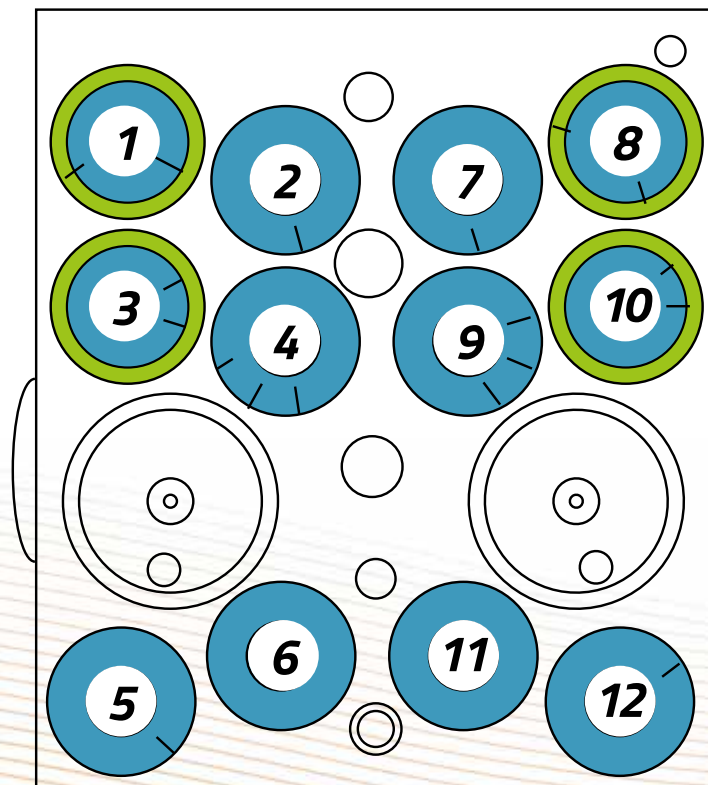
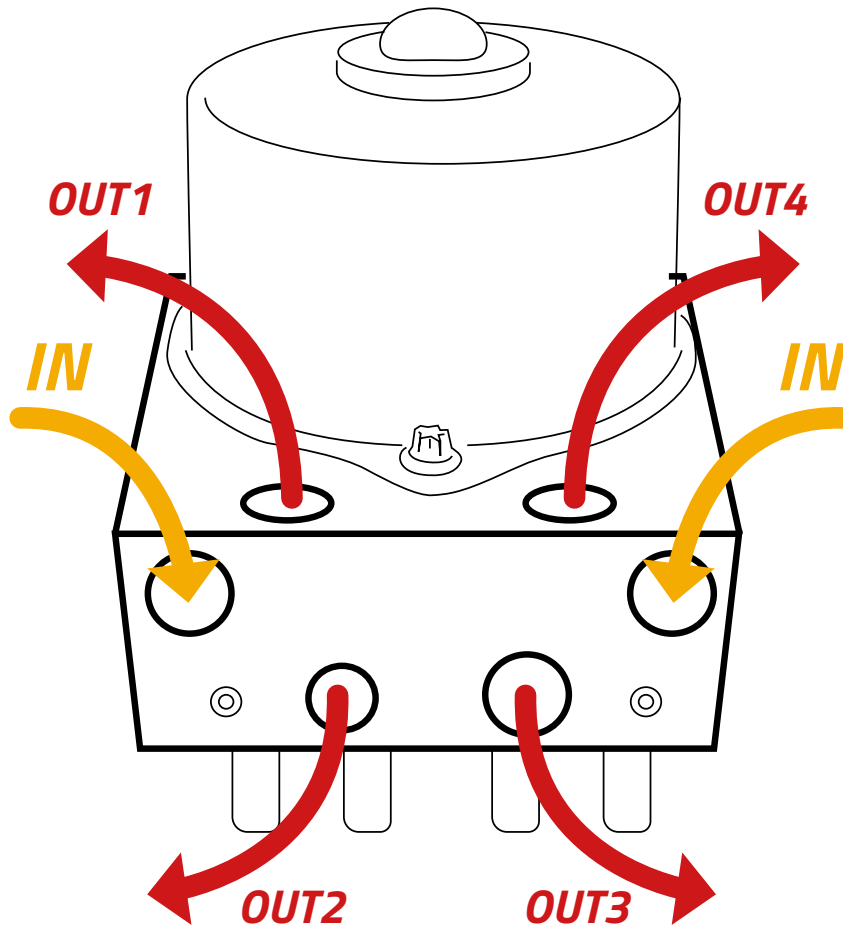

PG. 9

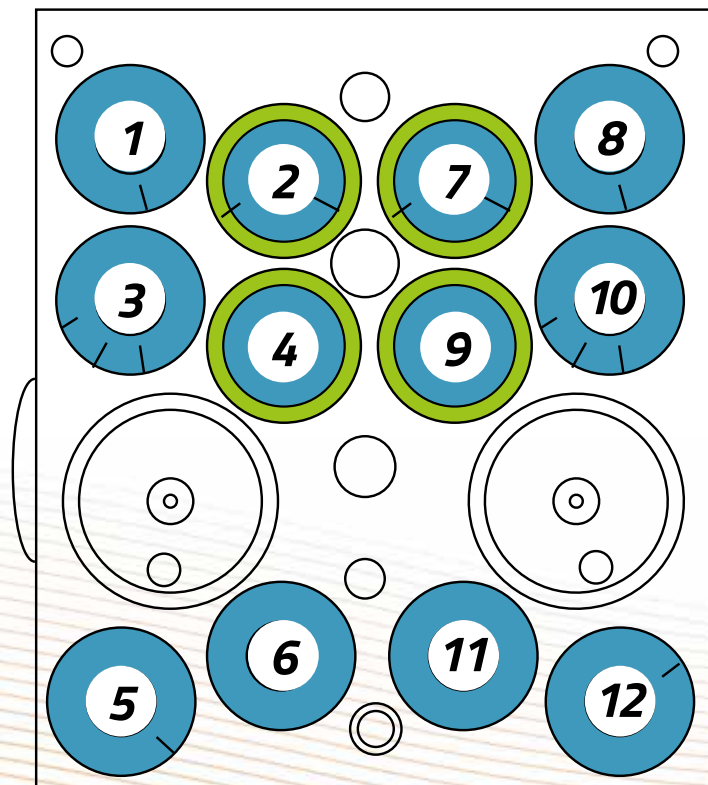
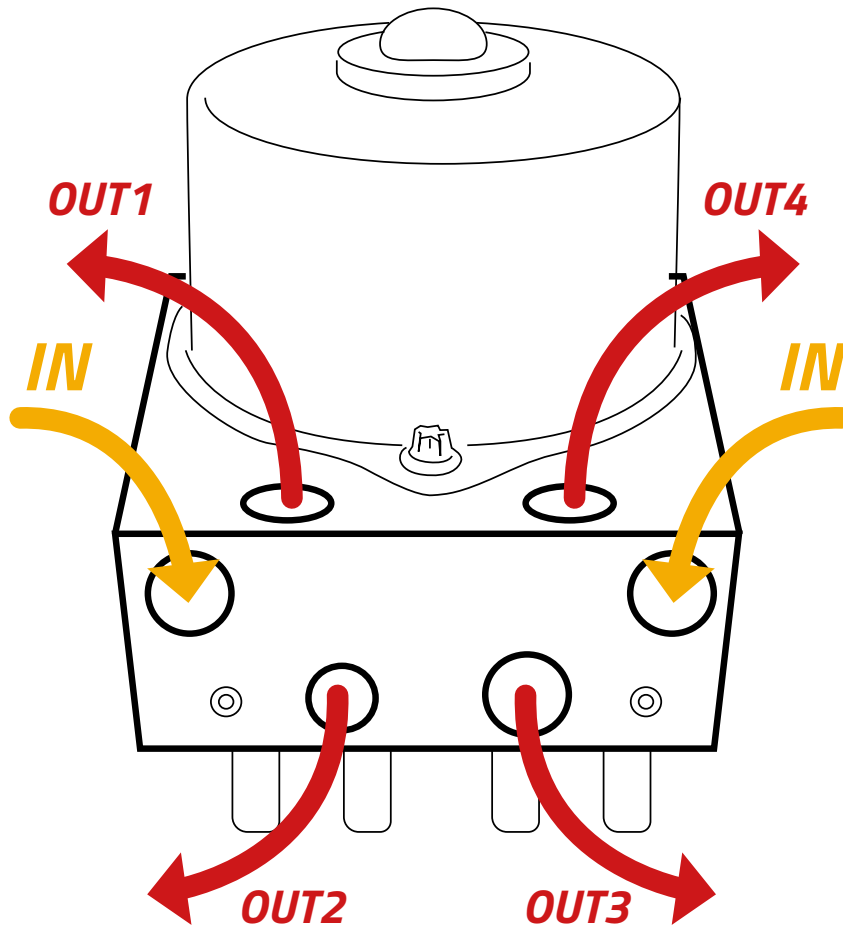



PG. 10

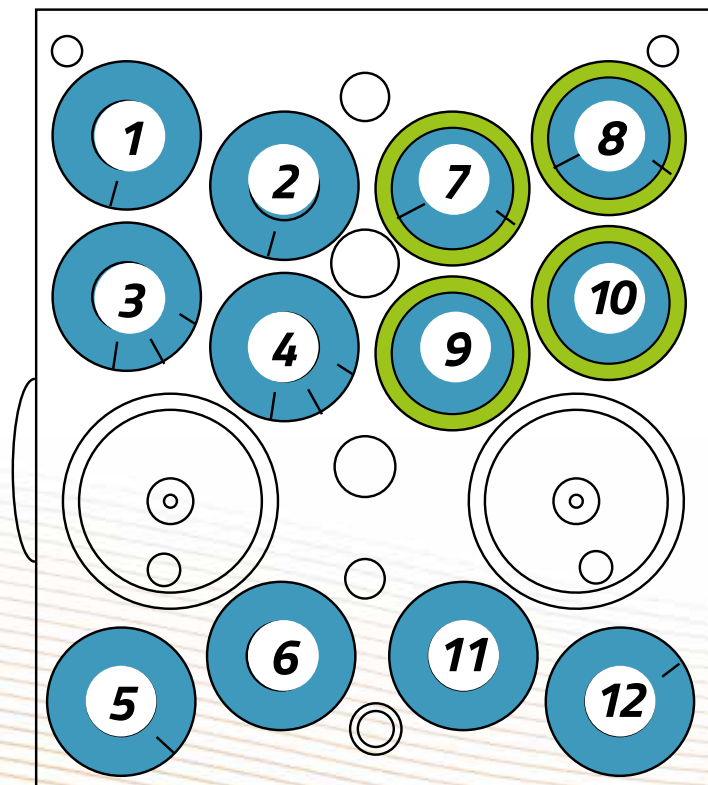
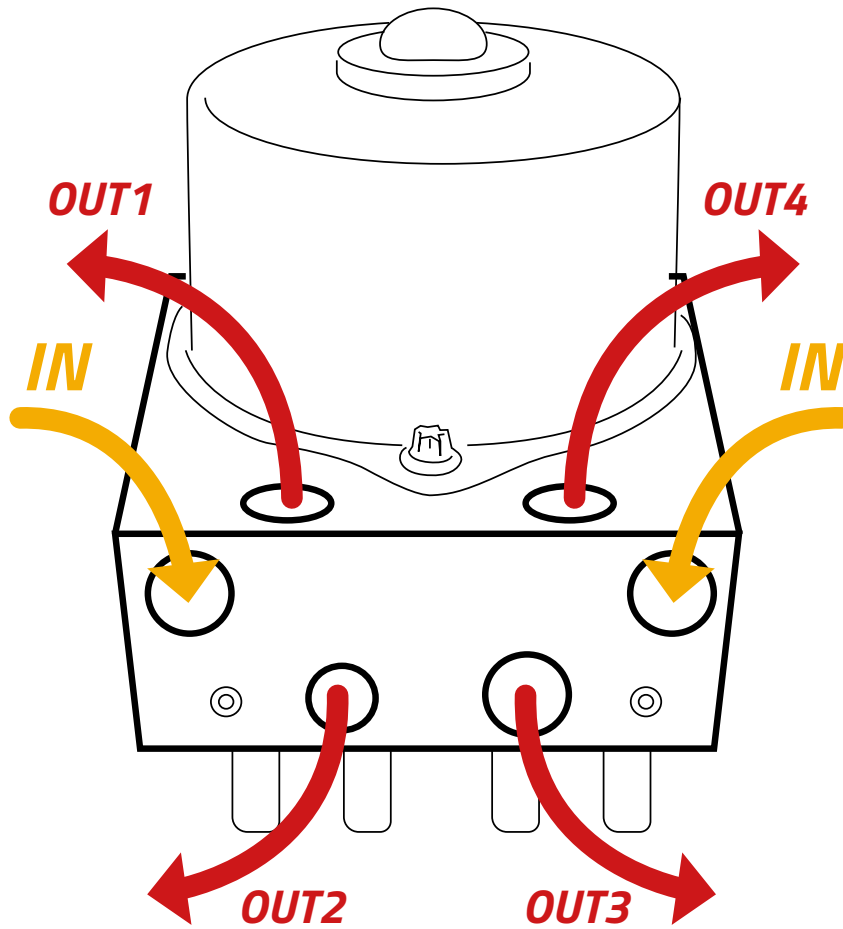

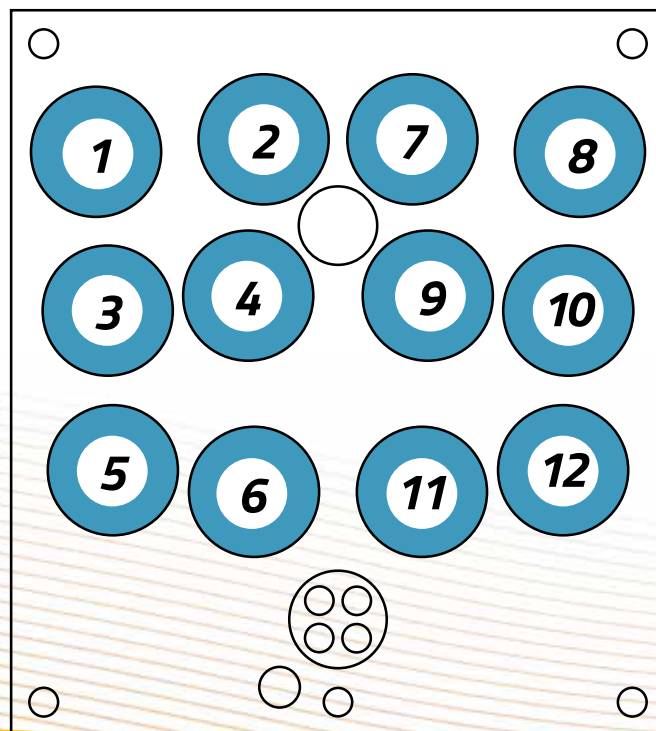
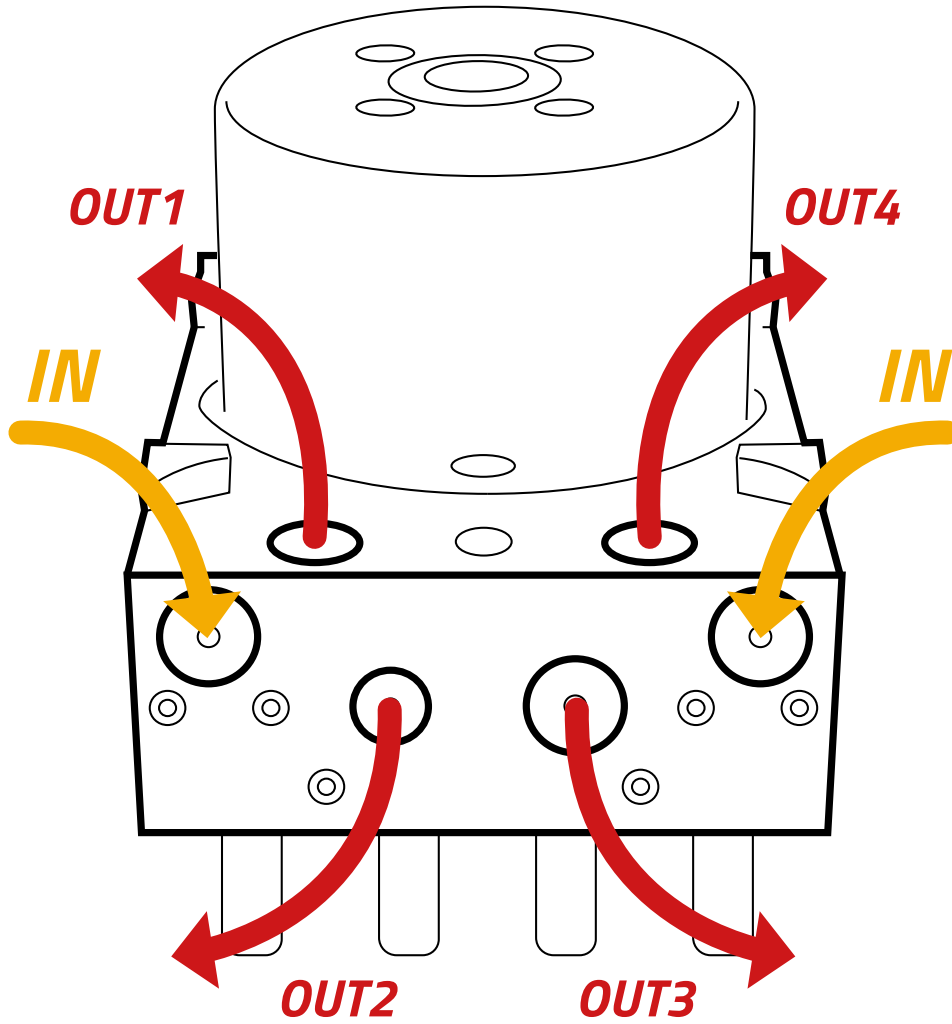

PG. 12

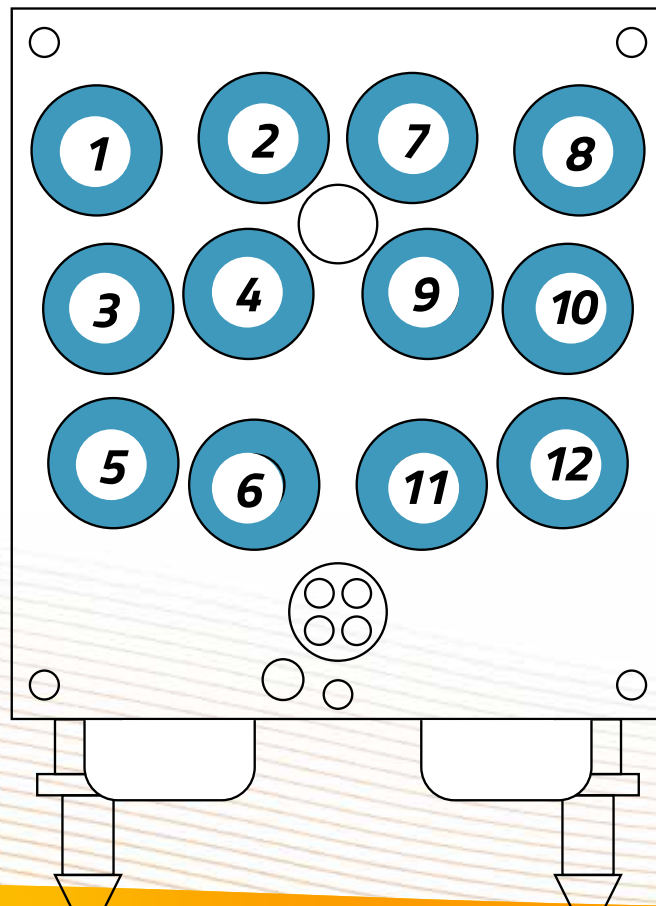
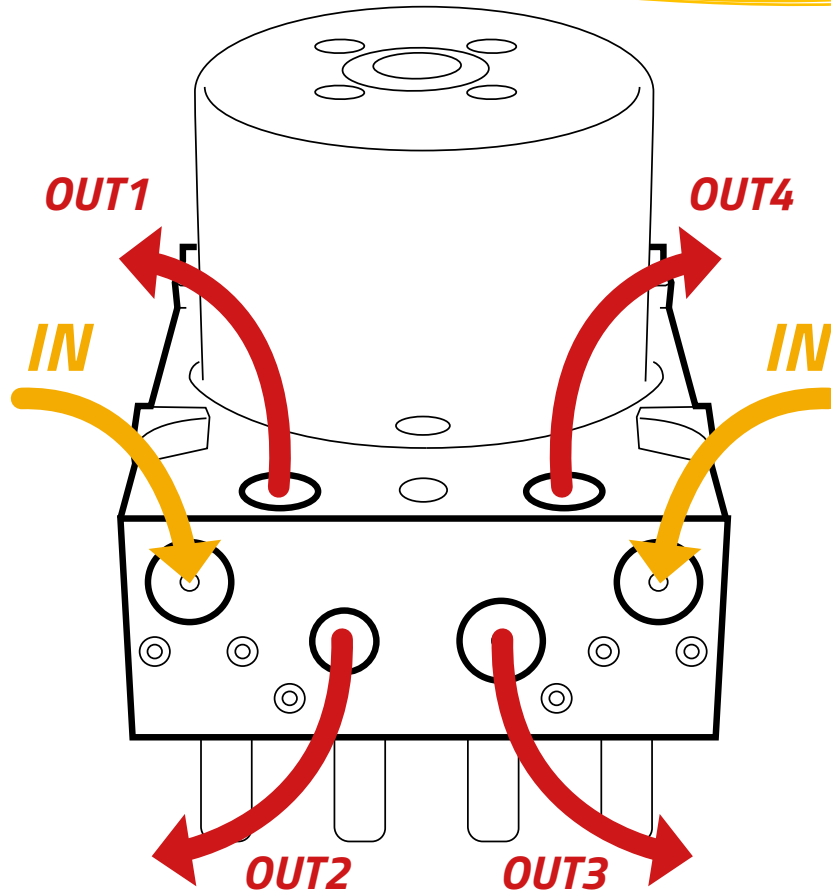

PG. 13

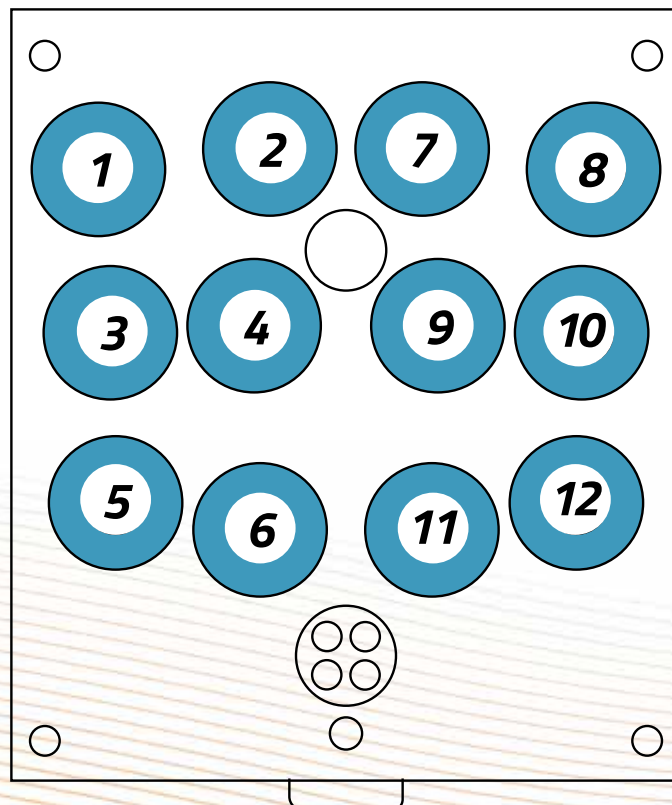
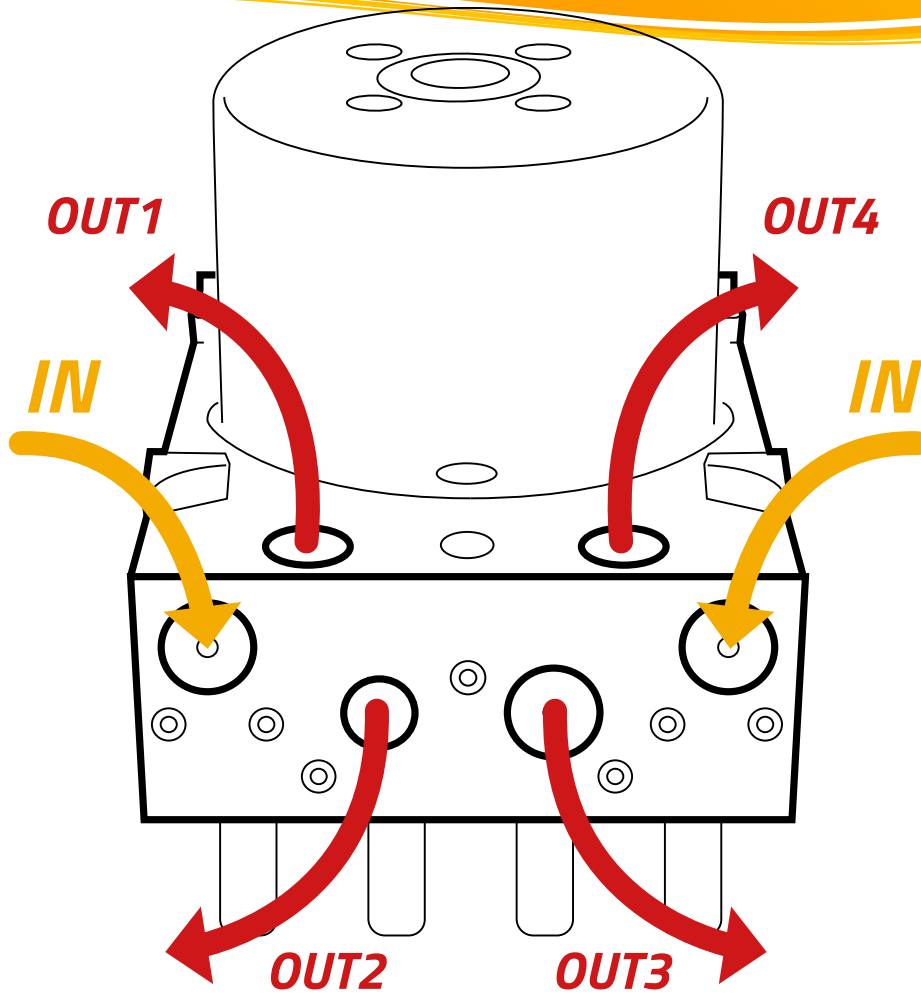

PG. 14

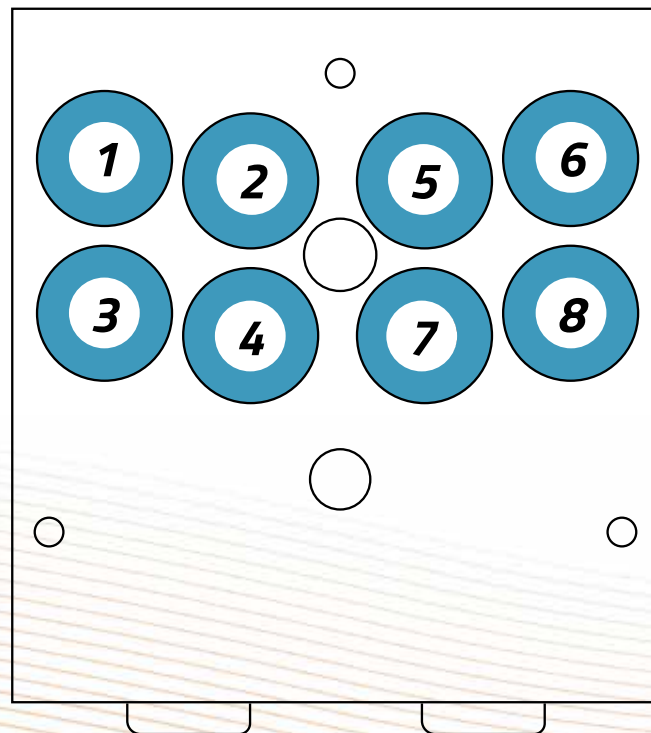
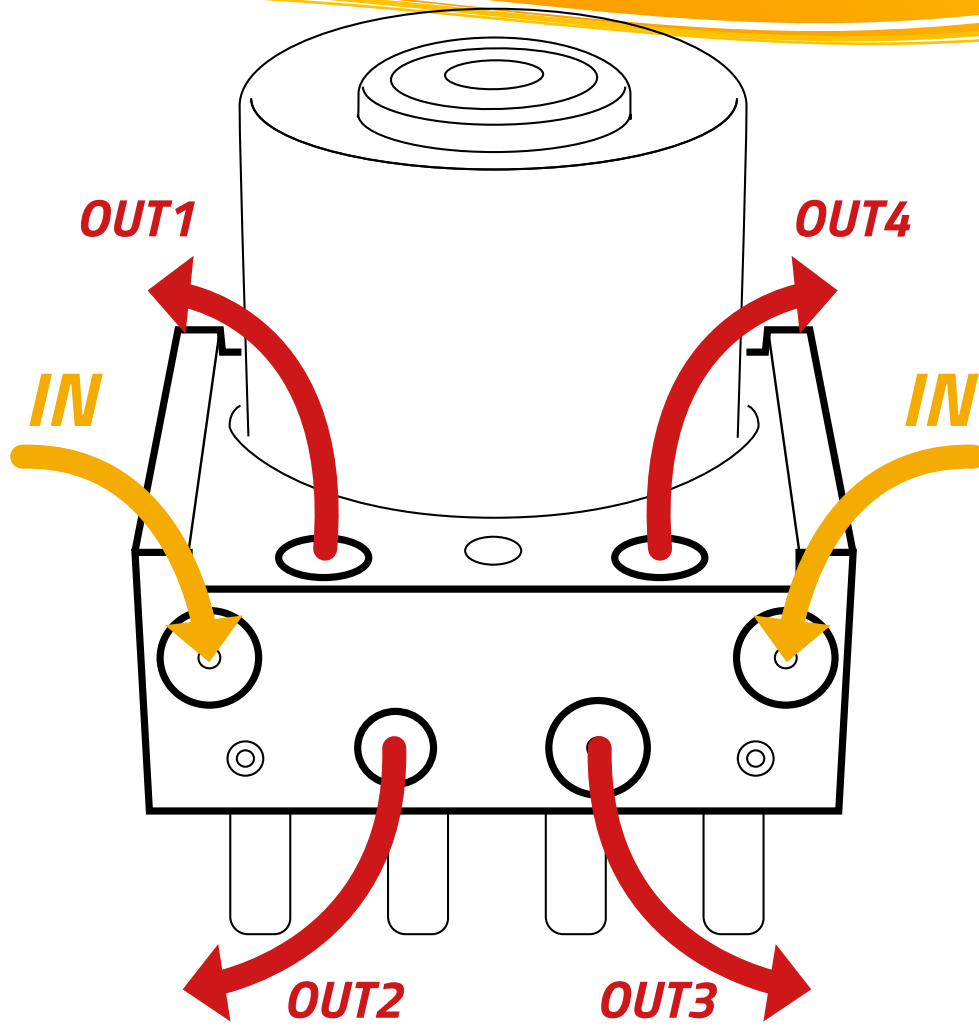



PG. 15

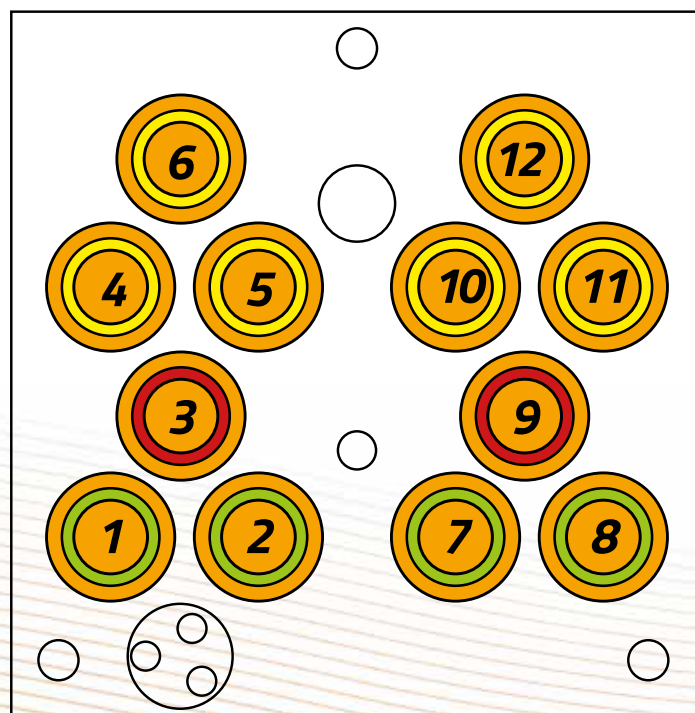
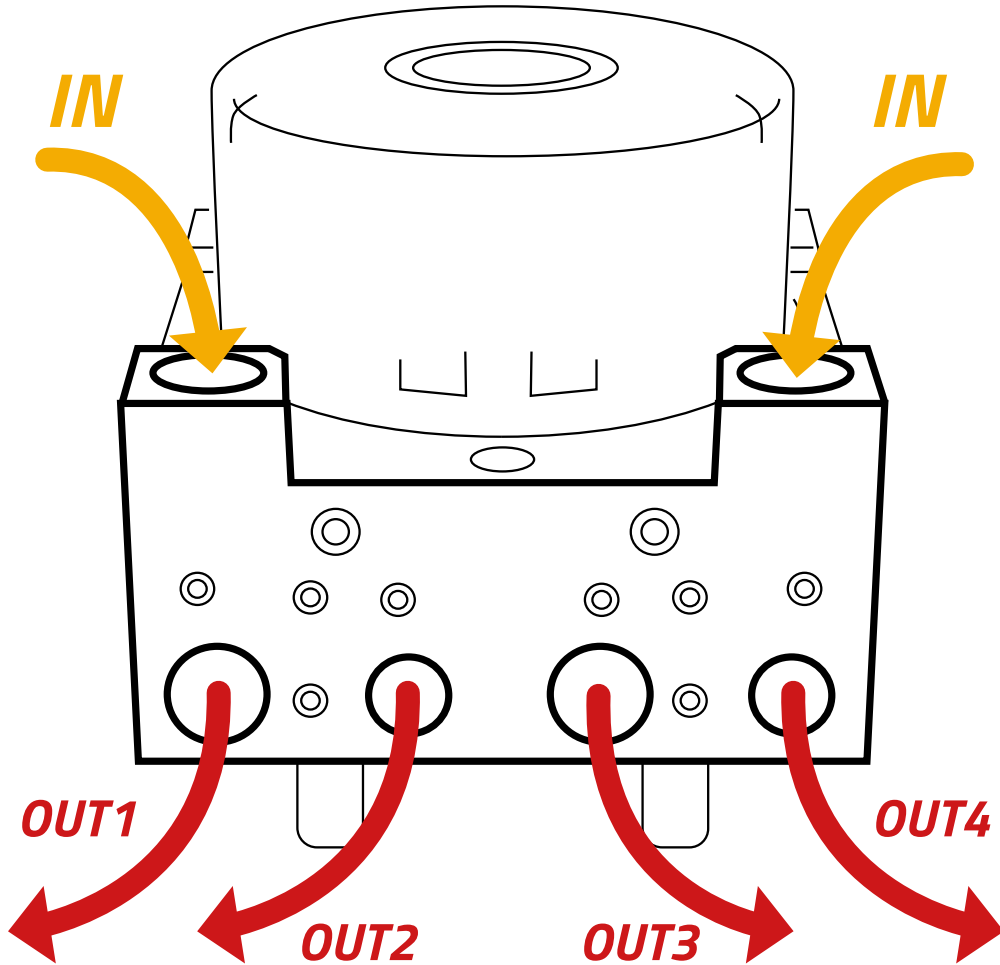

PG. 16

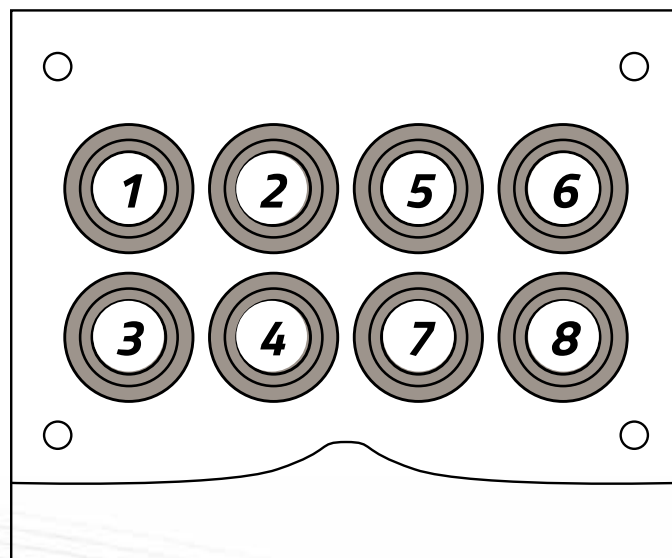
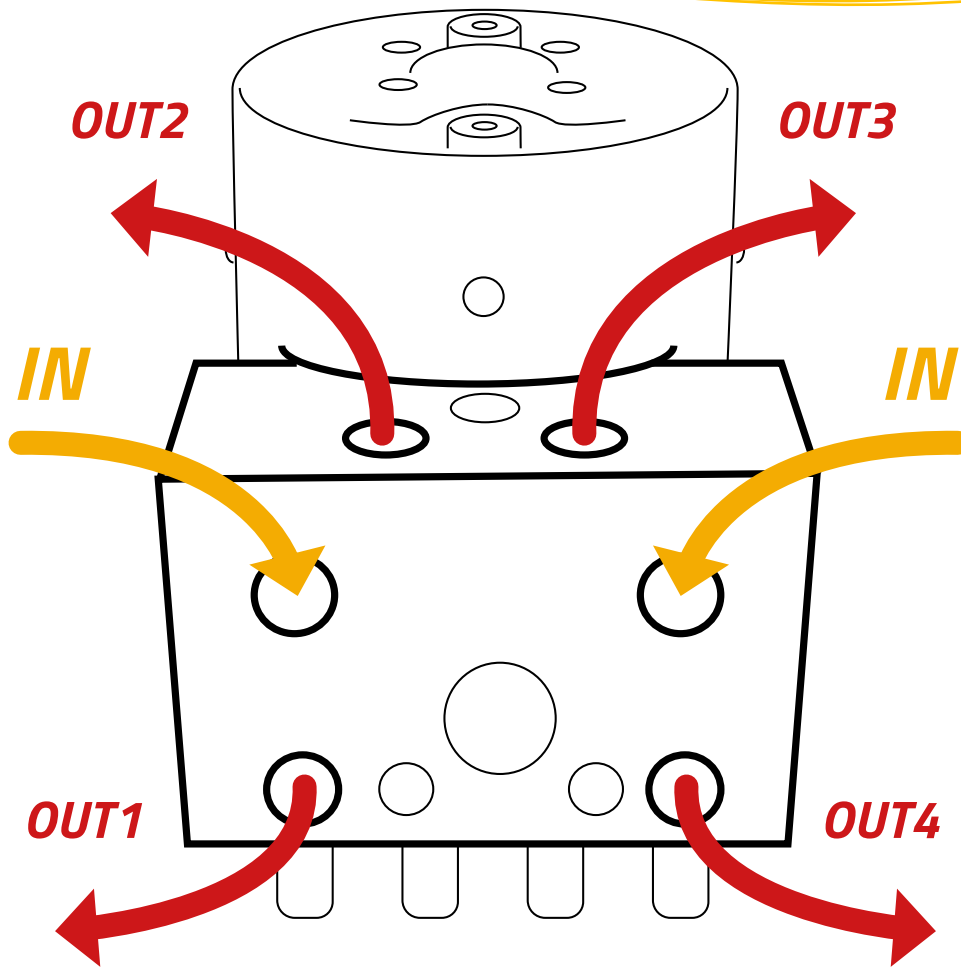

IN AGGIORNAMENTO

PG. 17

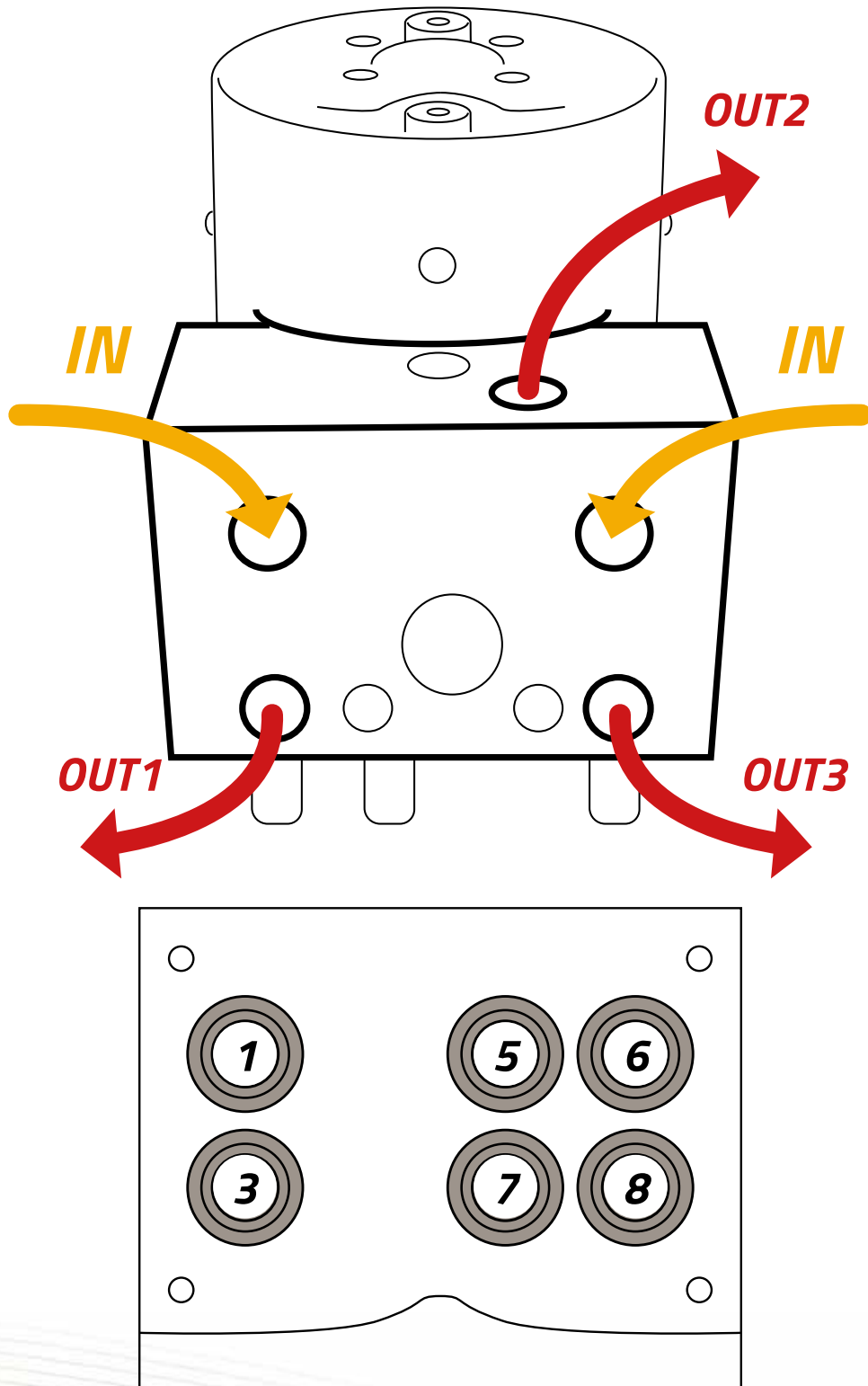

IN AGGIORNAMENTO



PG. 18

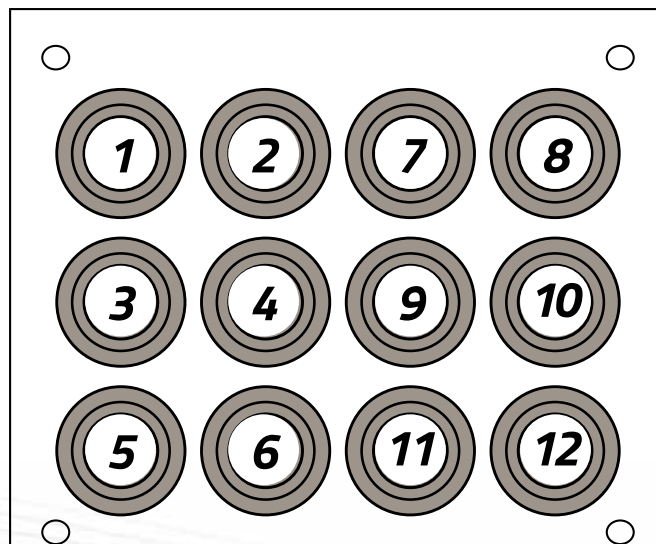
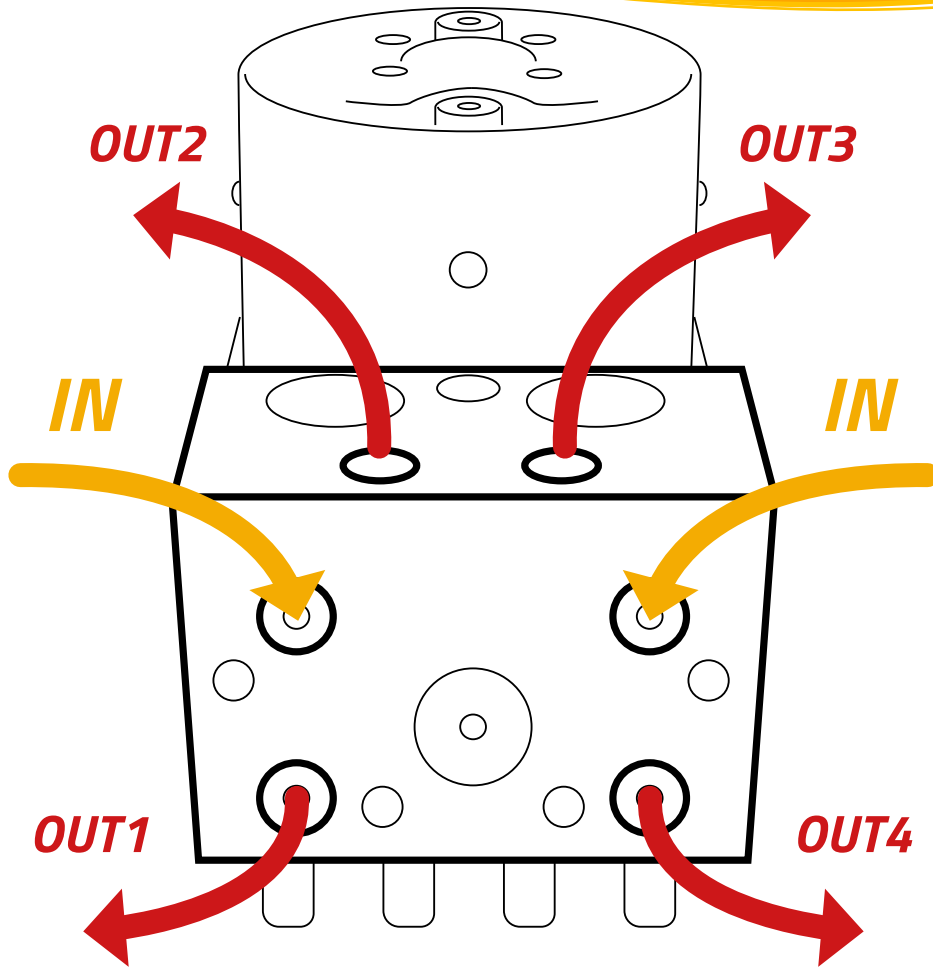

IN AGGIORNAMENTO

PG. 19

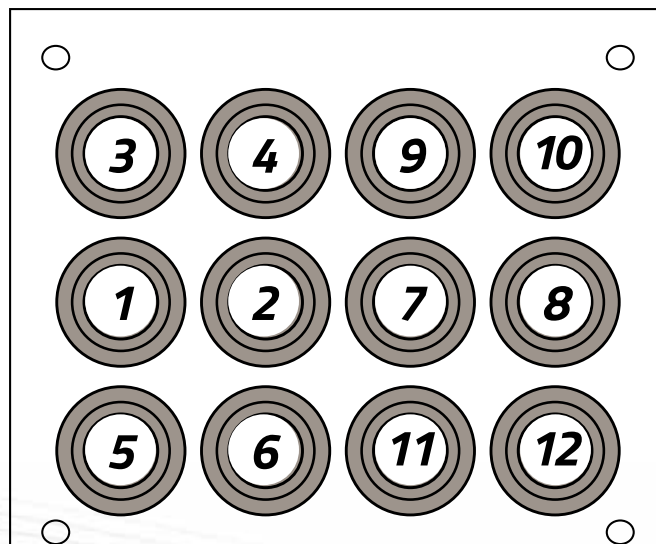
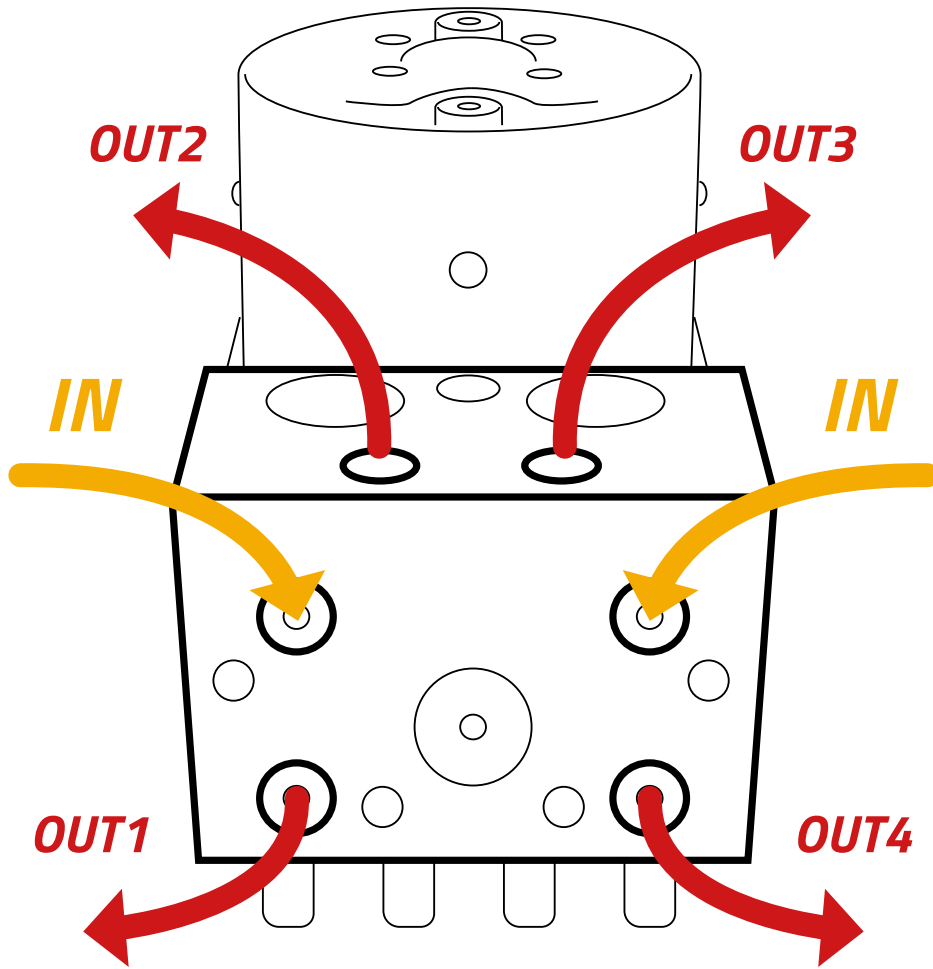

IN AGGIORNAMENTO



PG. 20

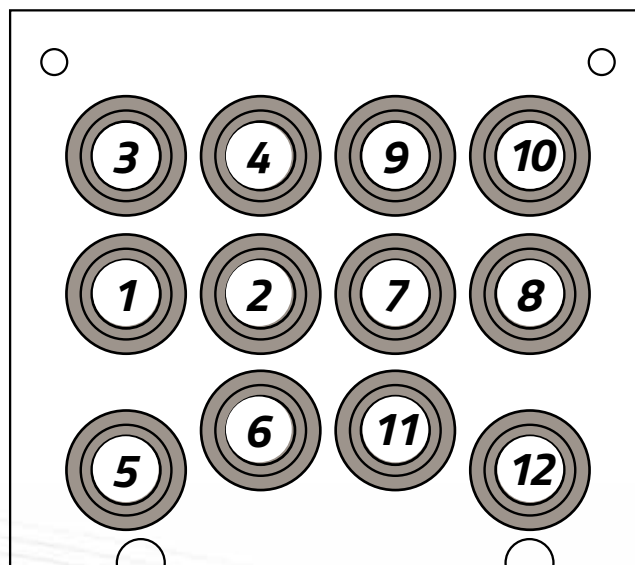
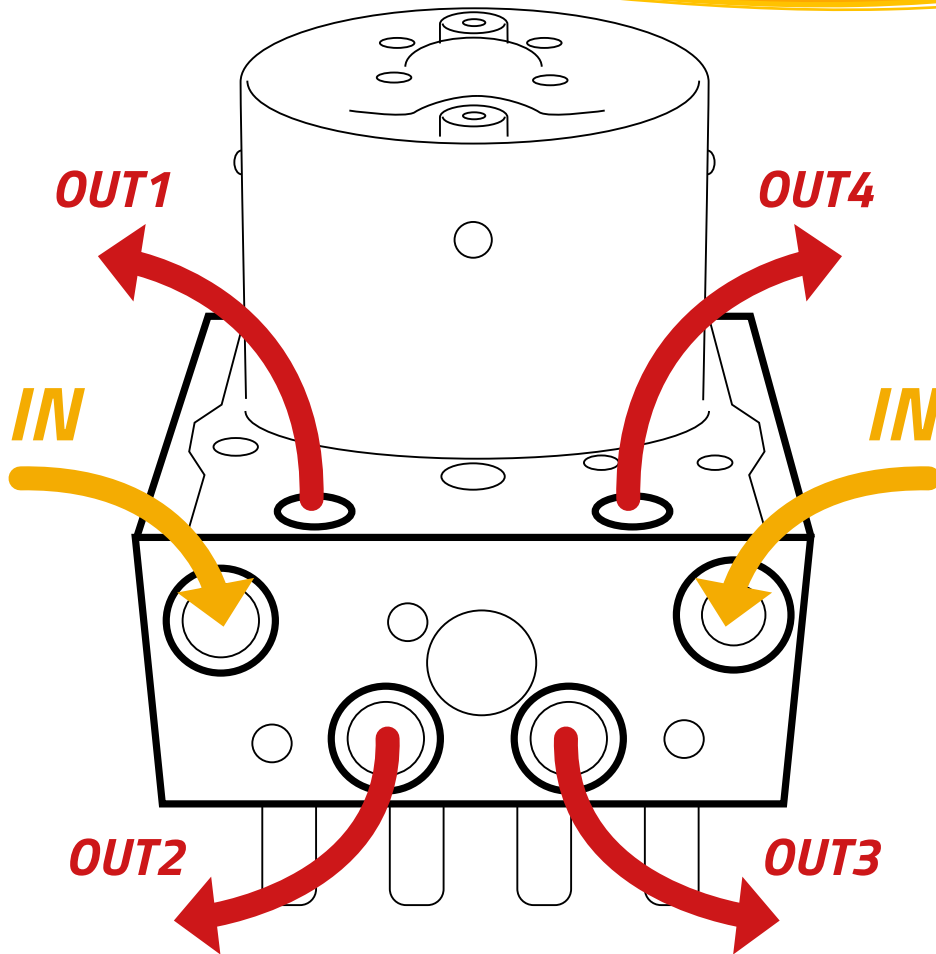

IN AGGIORNAMENTO



PG. 21

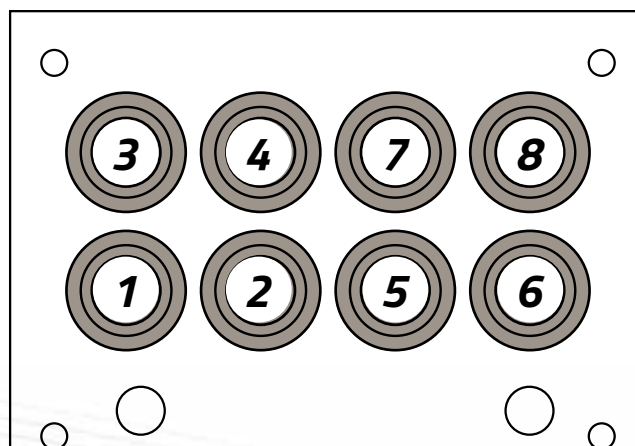
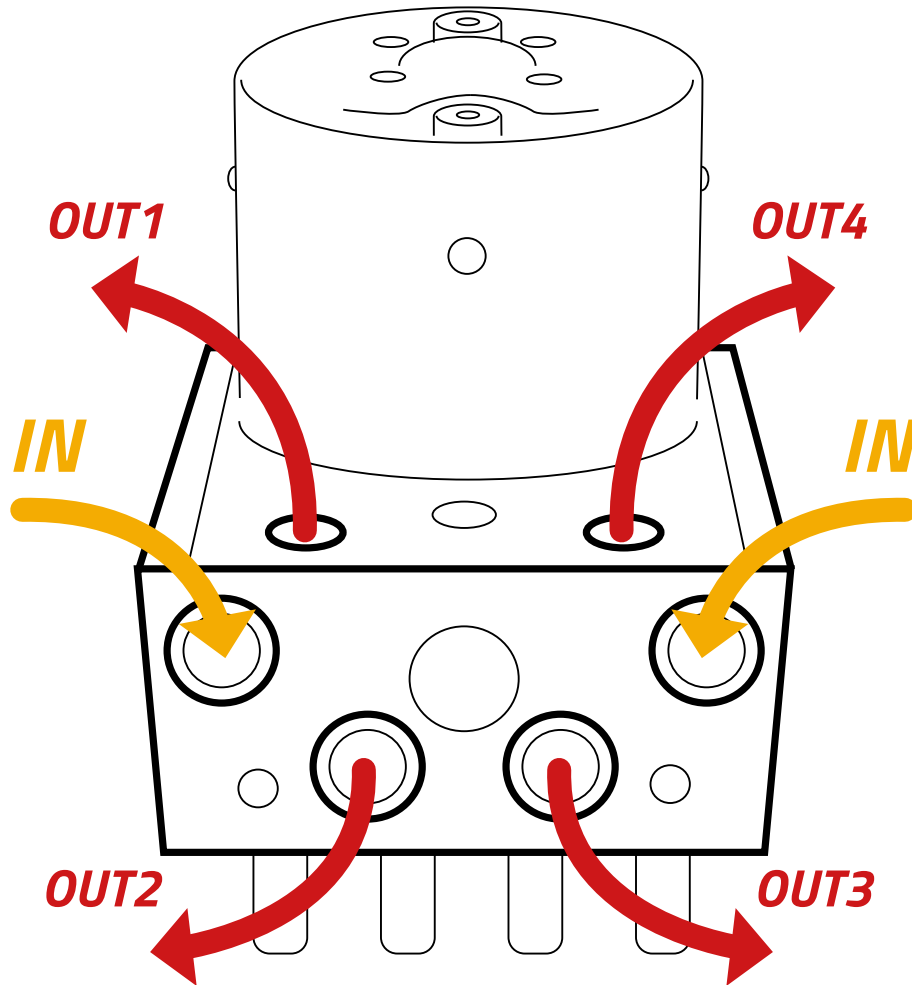

IN AGGIORNAMENTO



PG. 22

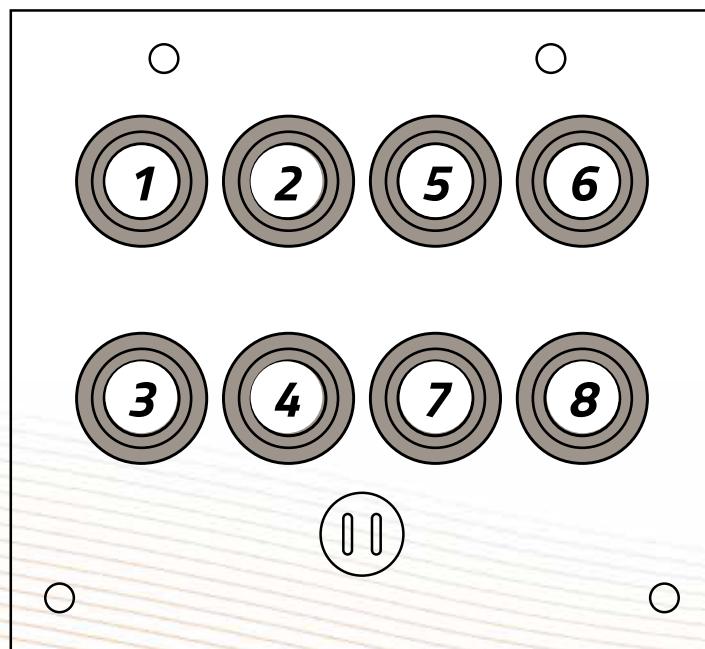
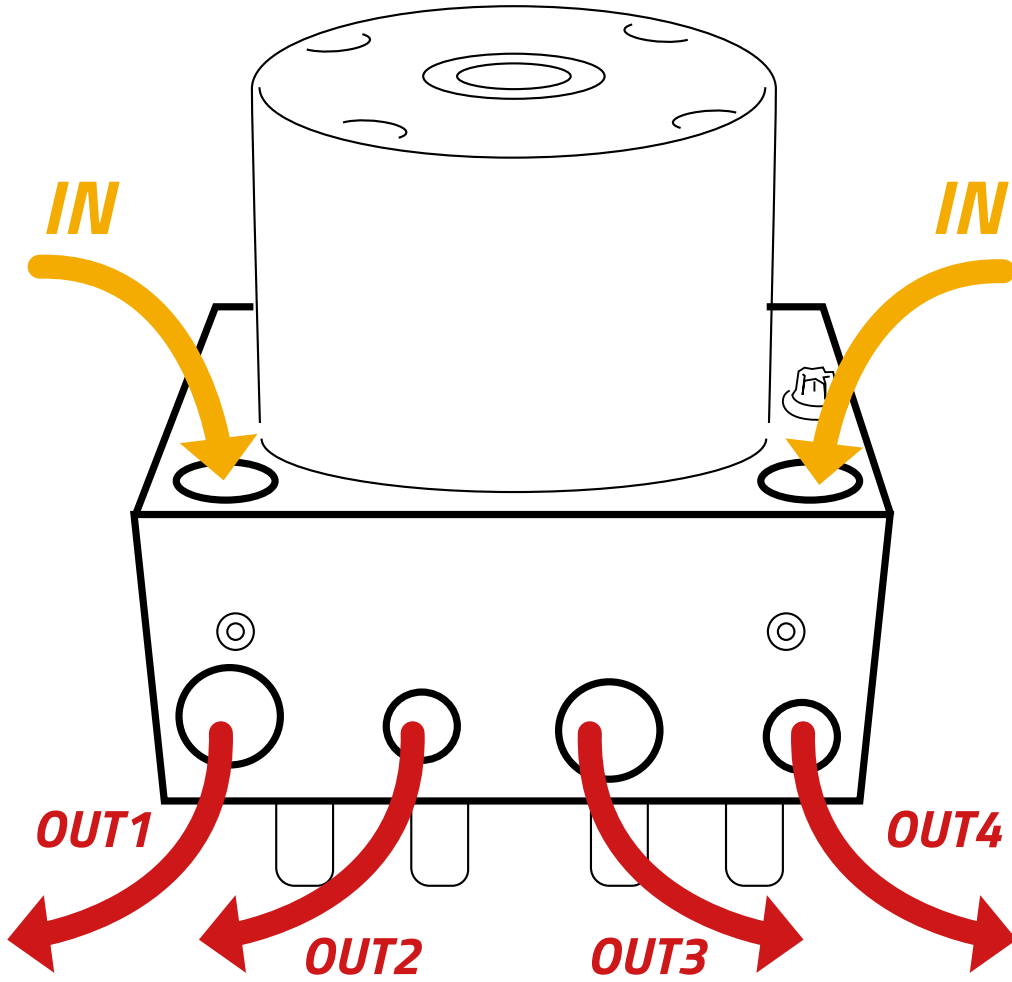



PG. 23

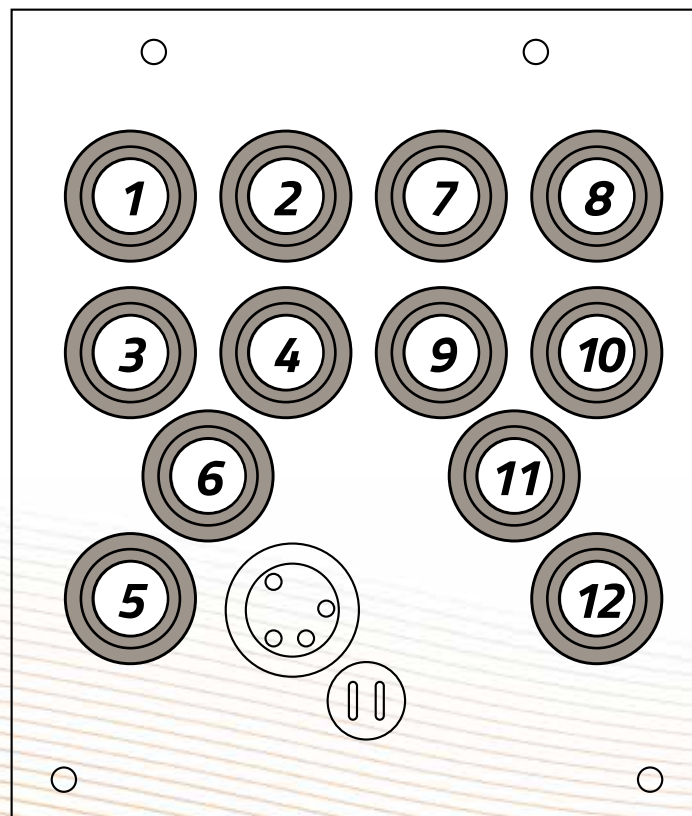
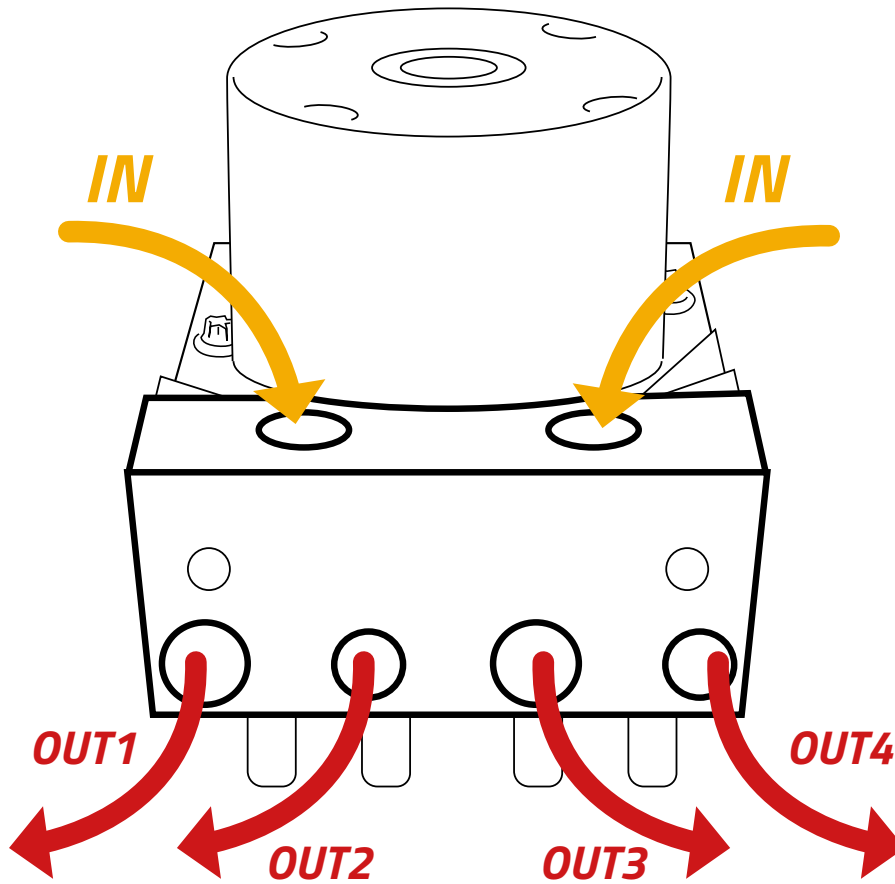

PG. 24

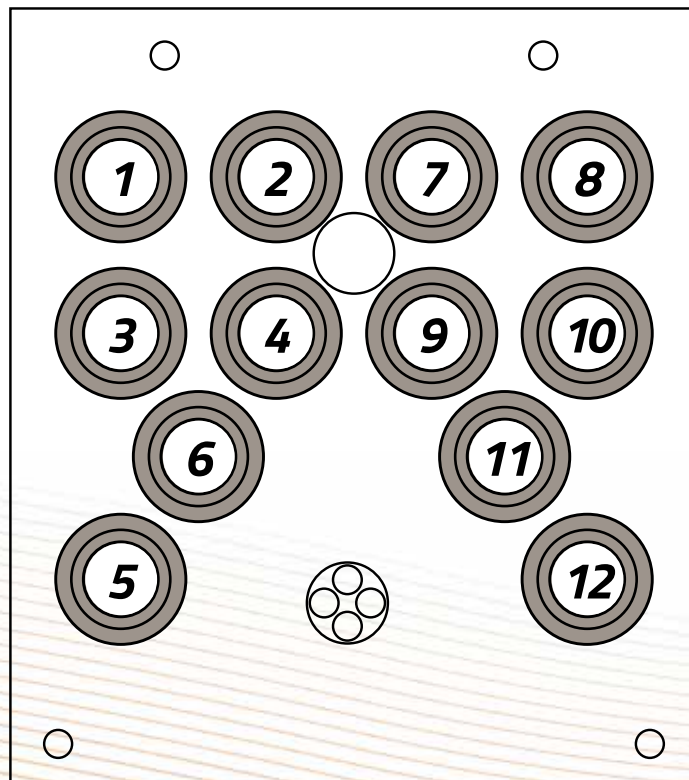
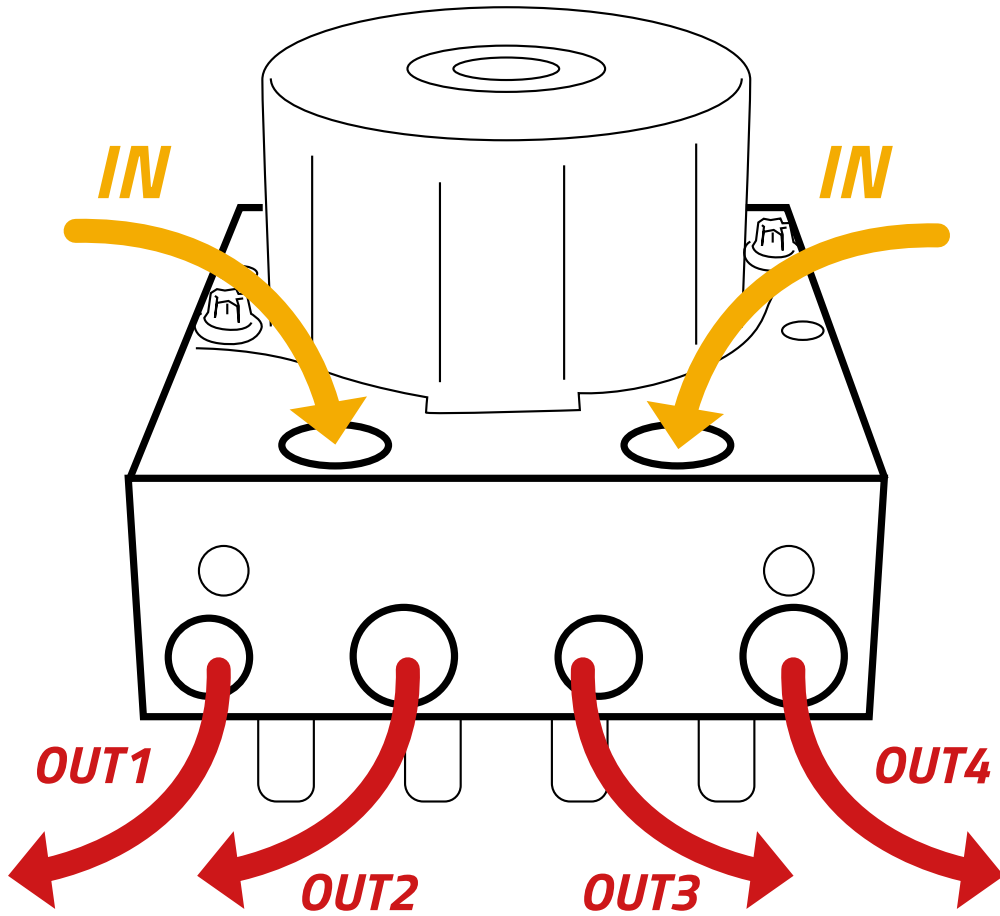



PG. 25

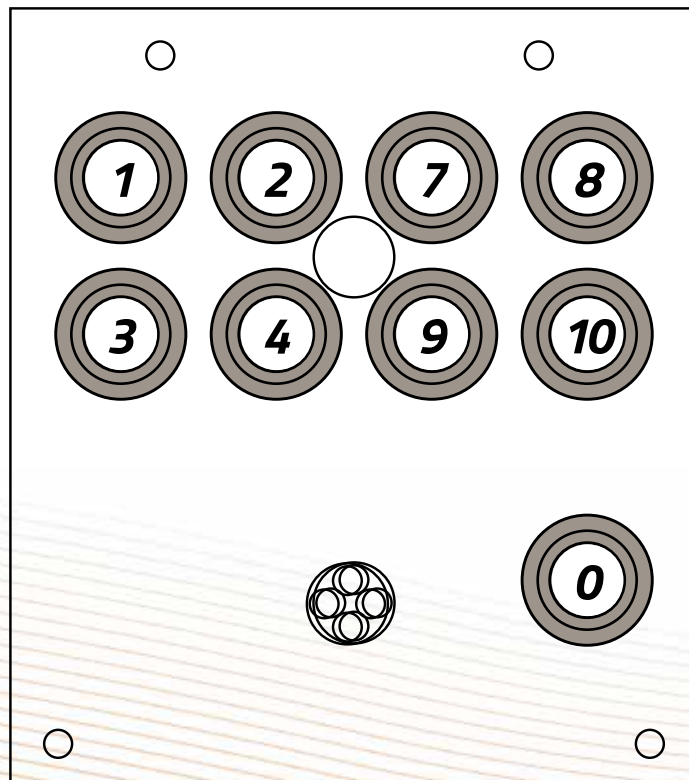
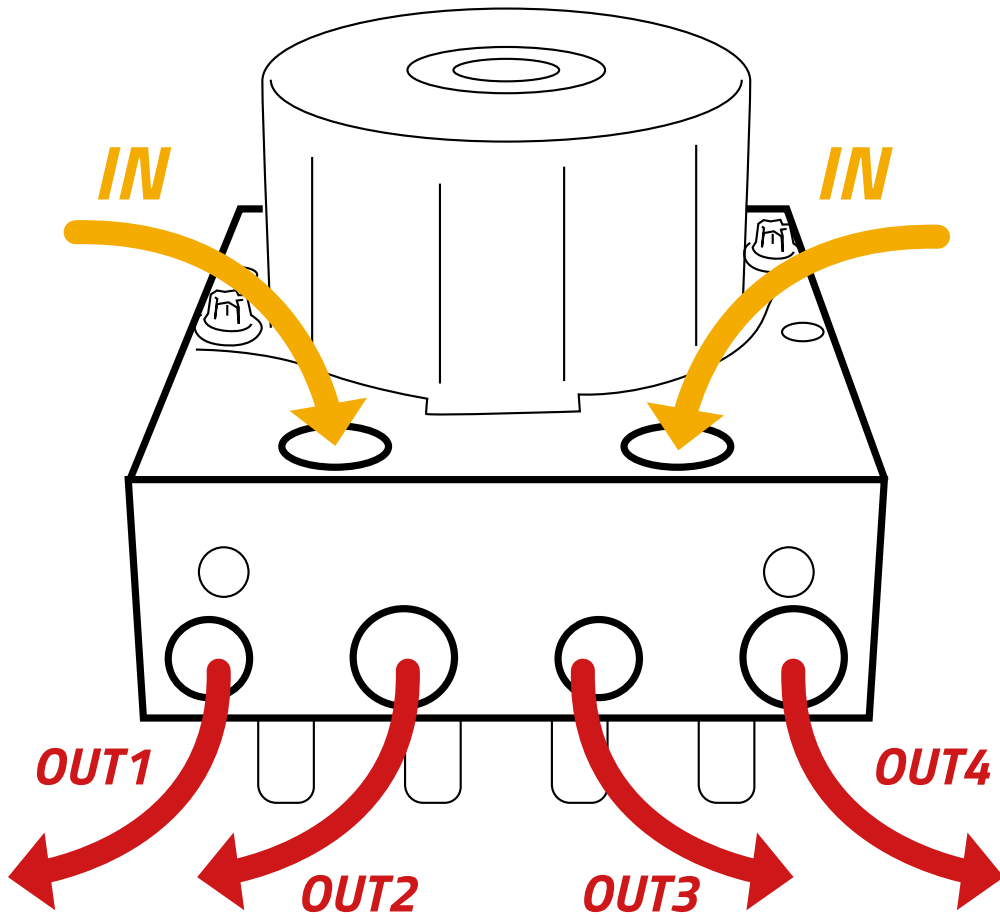



PG. 26

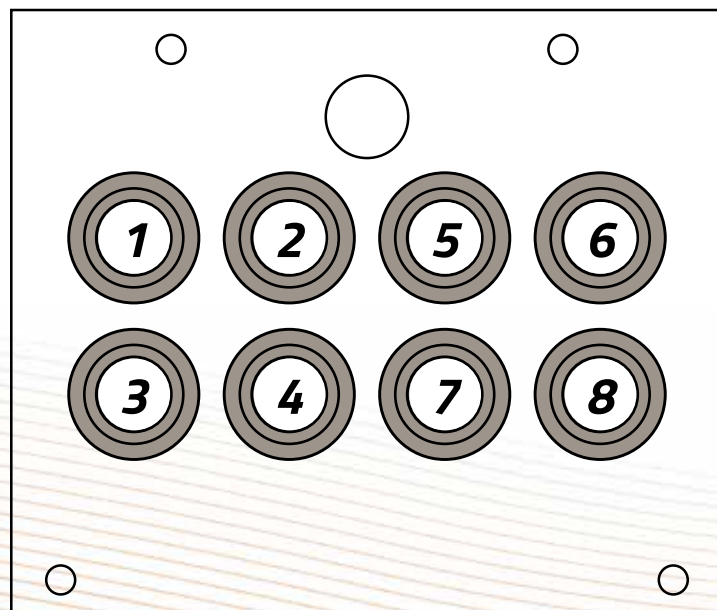
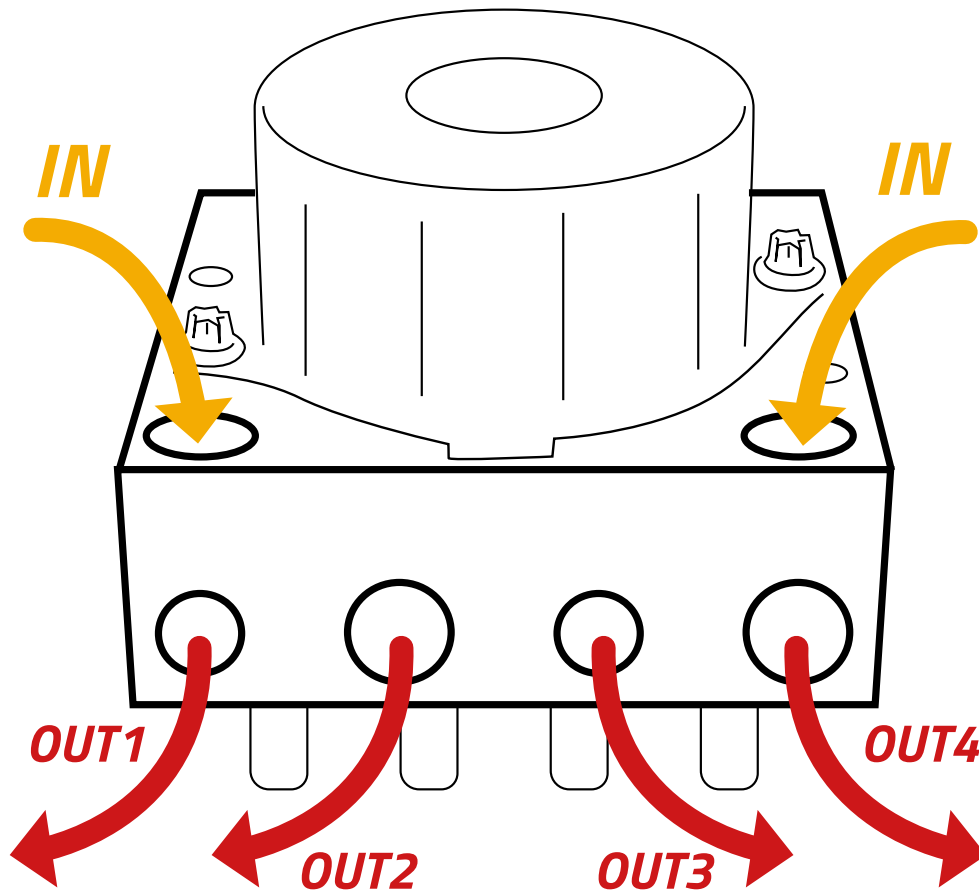

NON LAVORABILE

***TEST CENTRALINA SU BANCO
ELETTRONICO
COMING SOON***



PG. 28

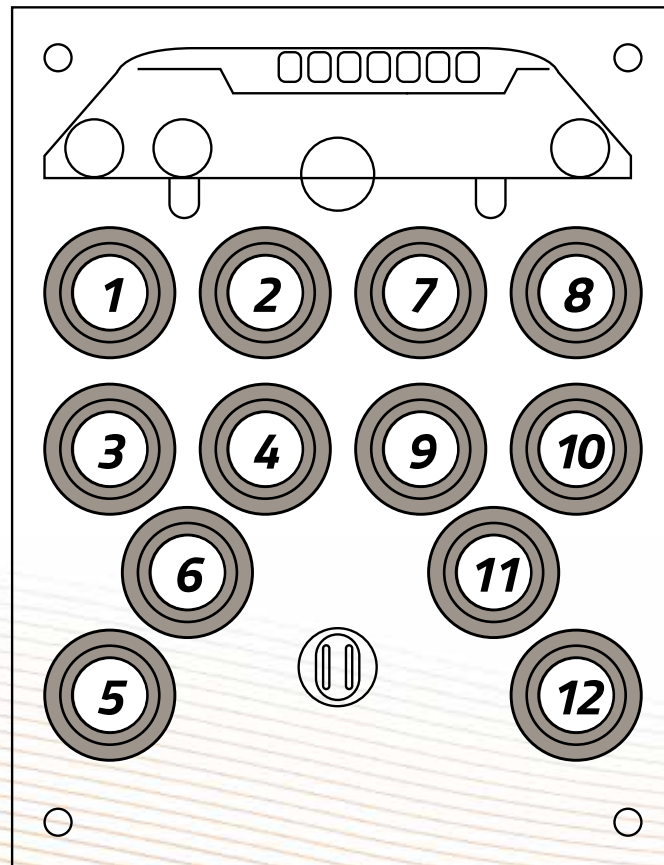
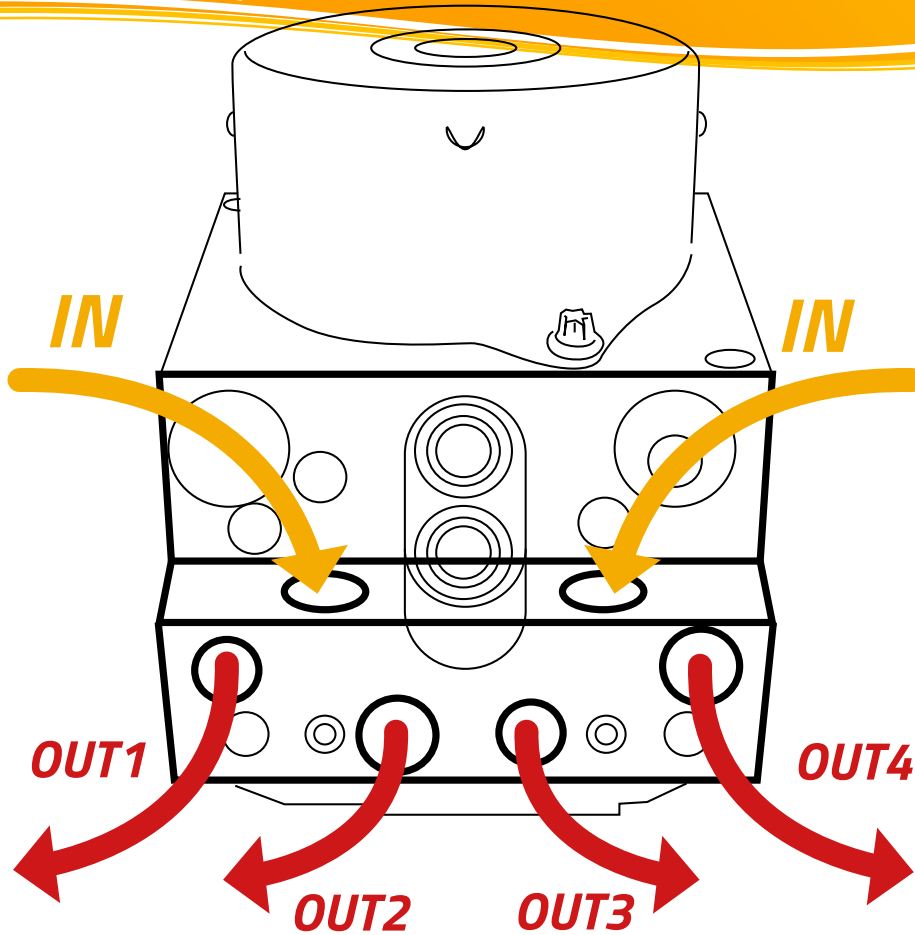



PG. 29

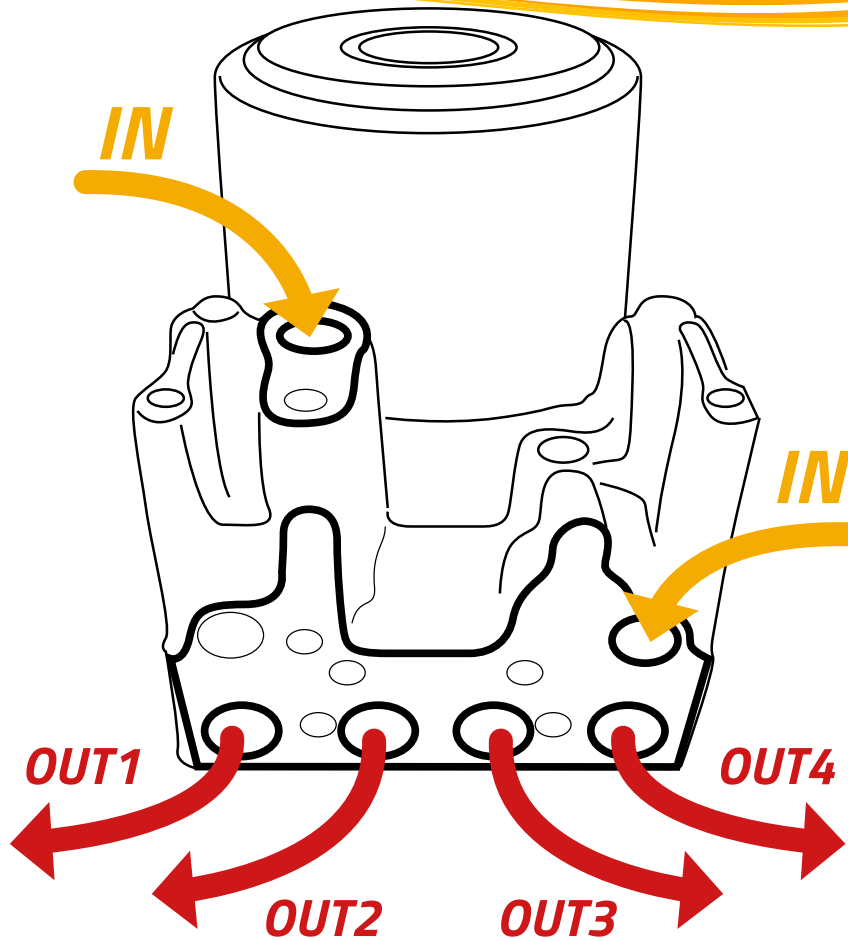

IN AGGIORNAMENTO

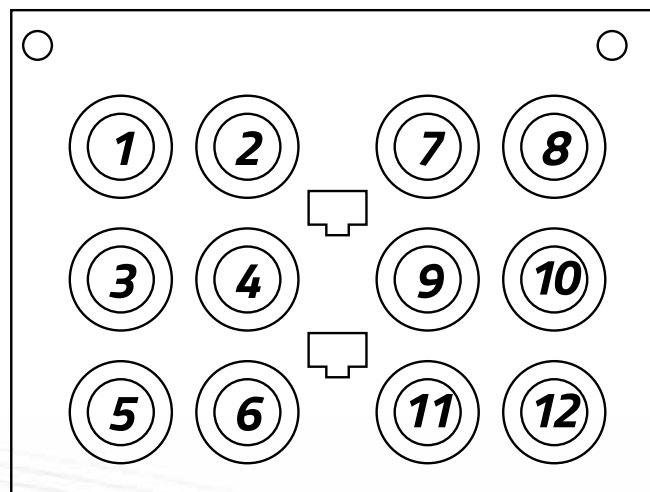
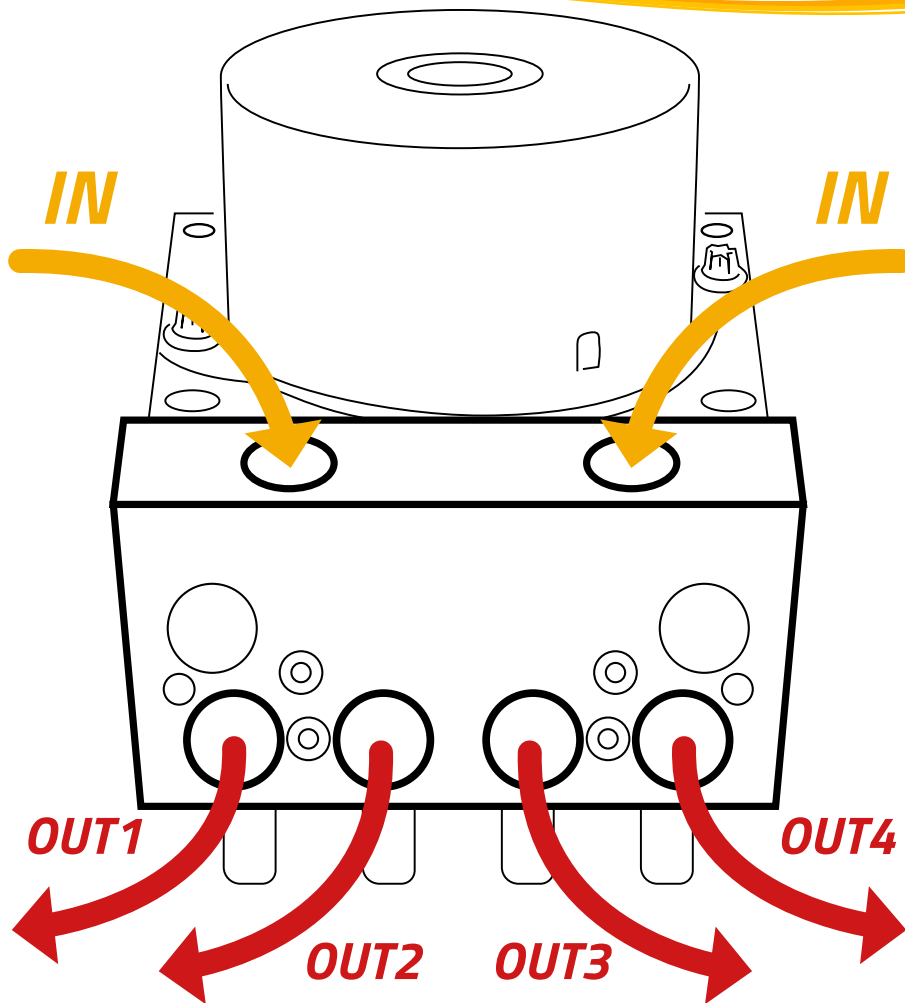

IN AGGIORNAMENTO

PG. 31

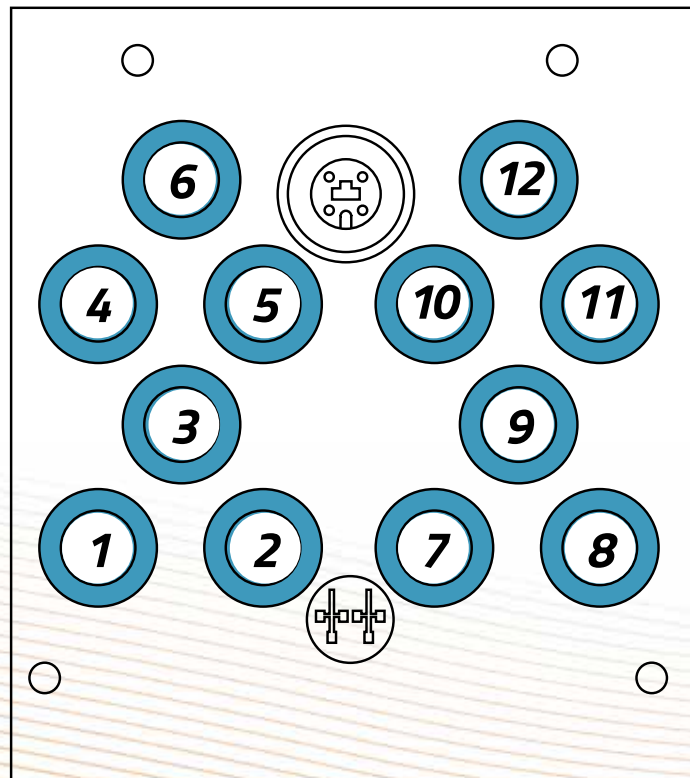
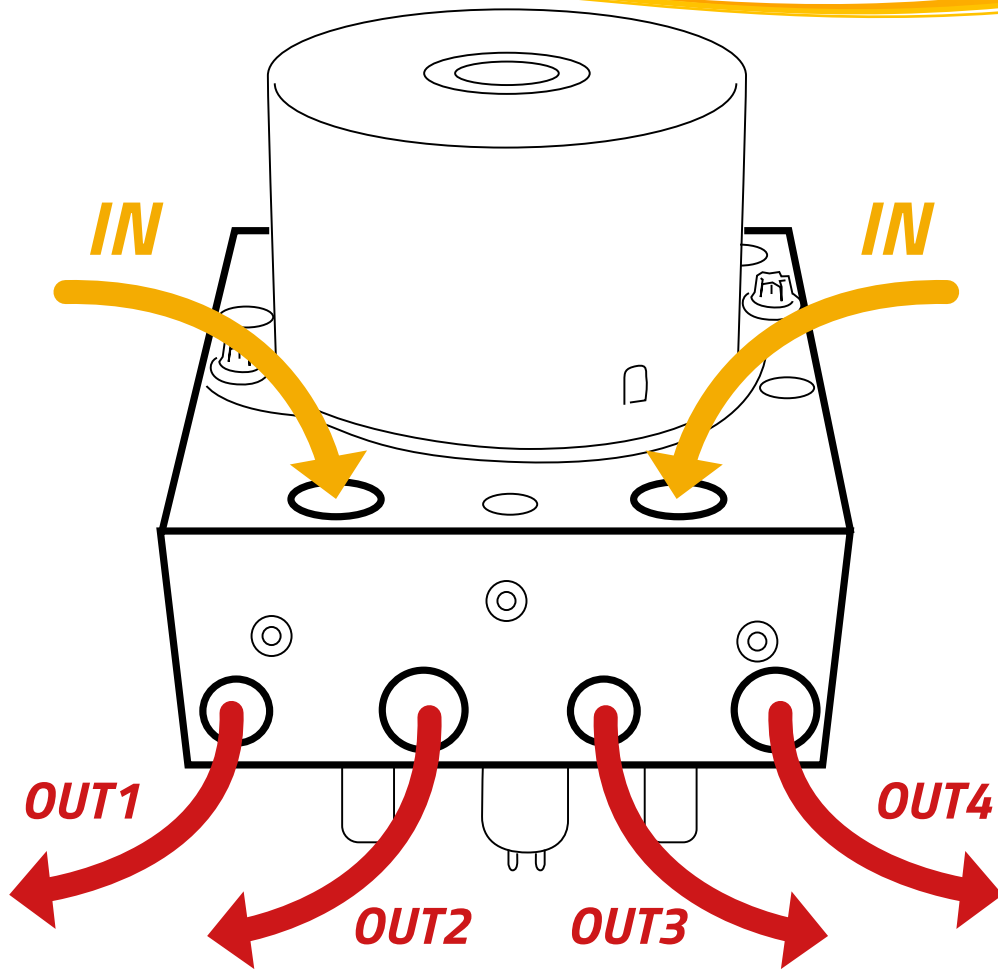



PG. 32

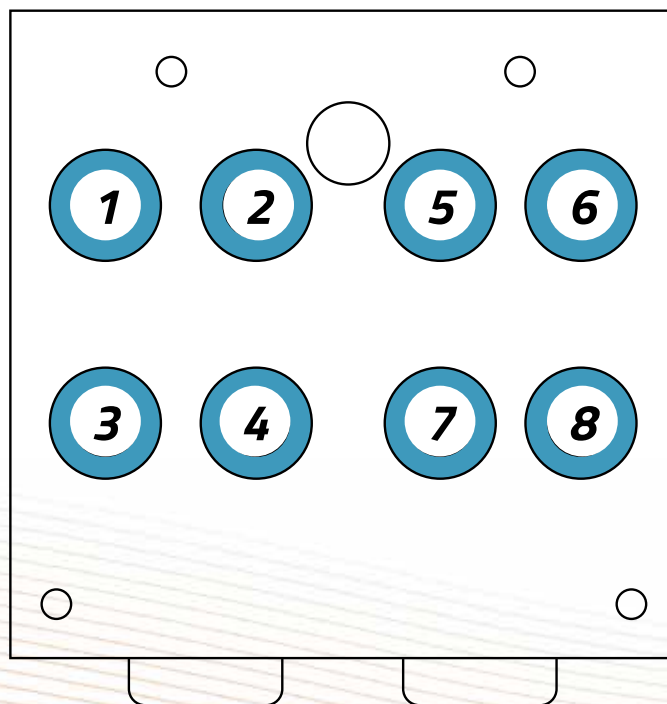
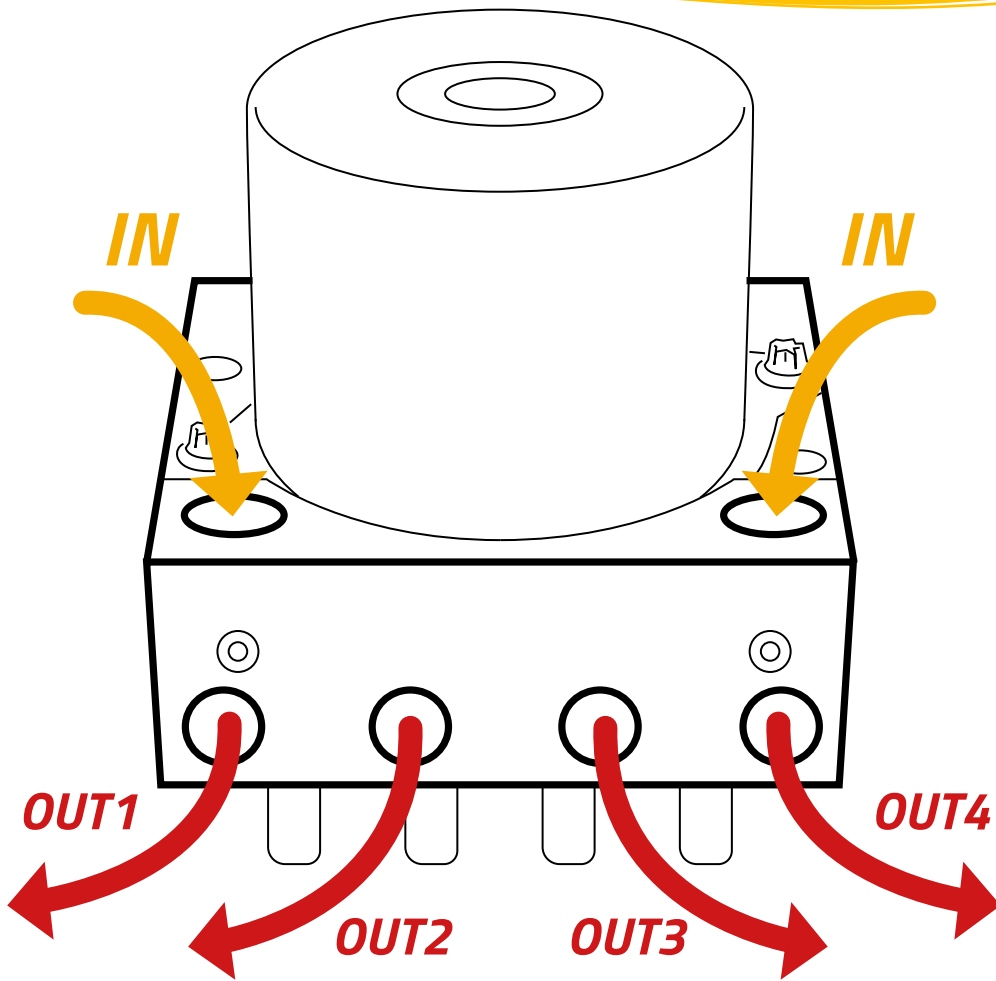



PG. 33

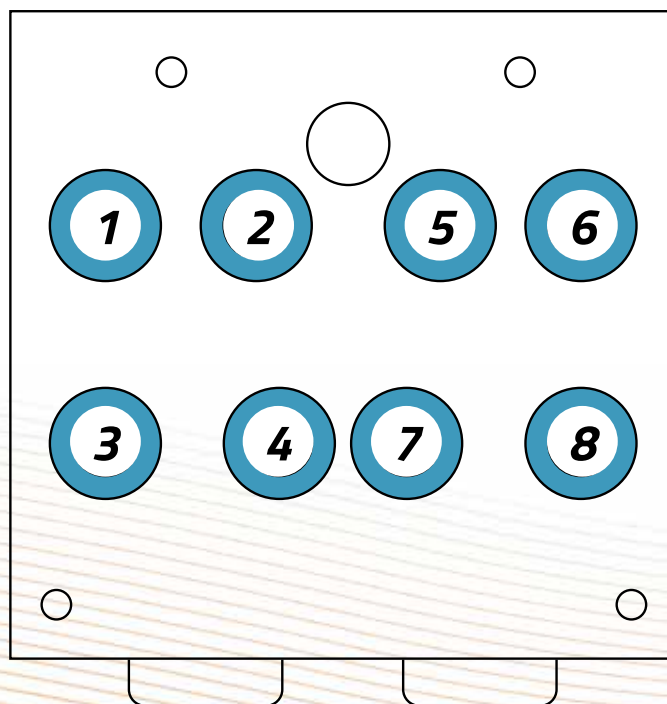
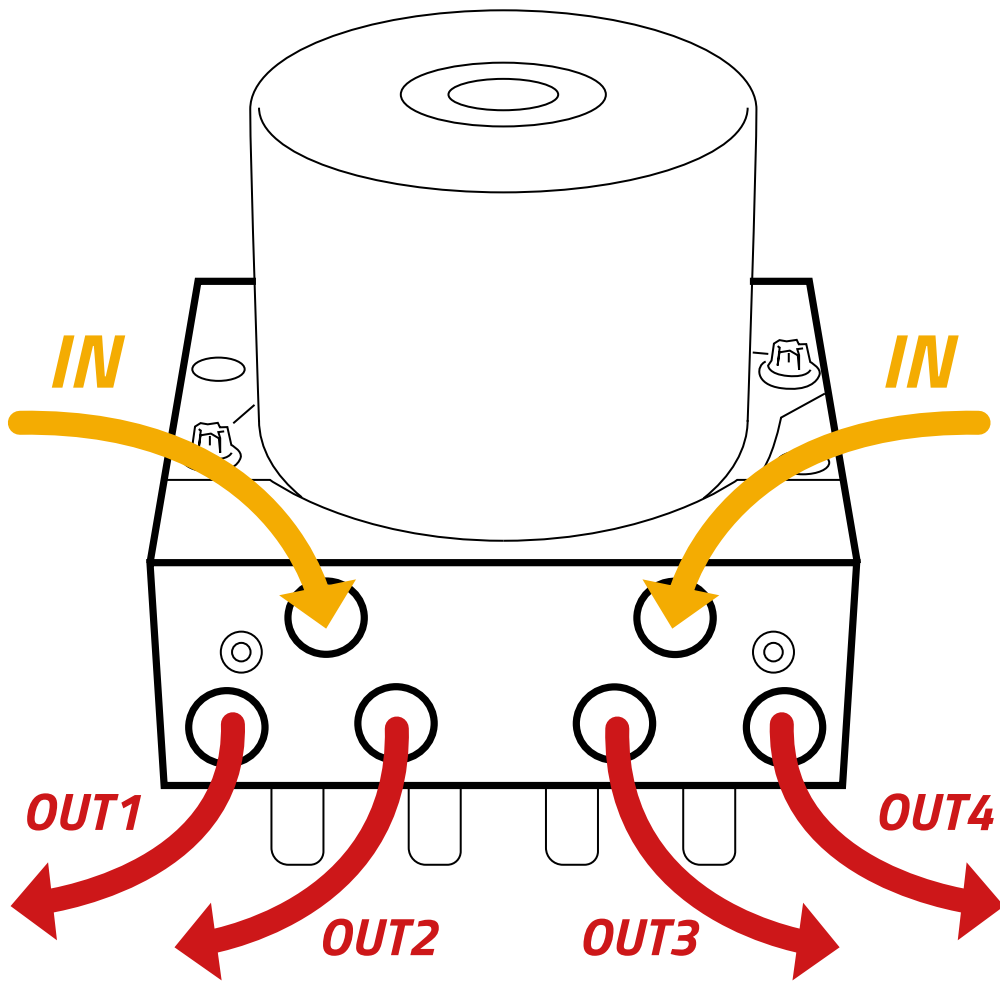

PG. 34

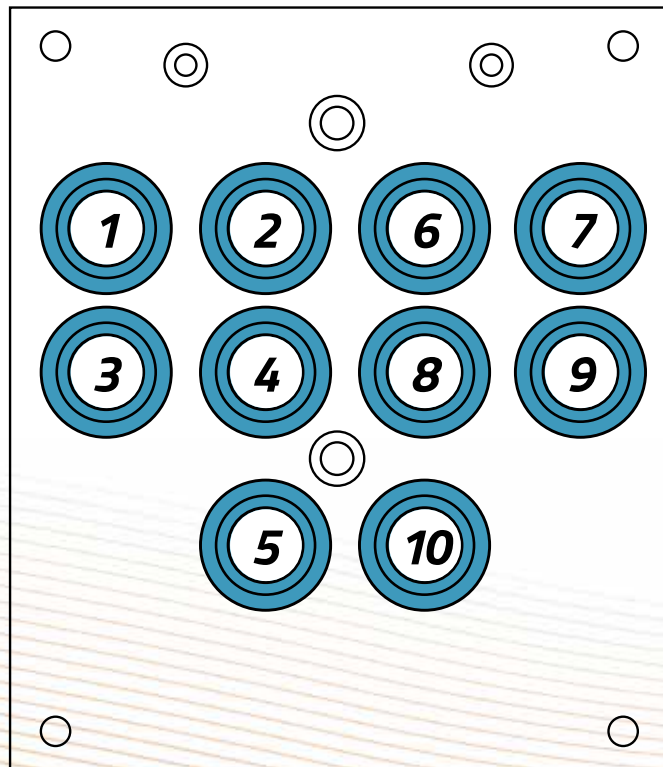
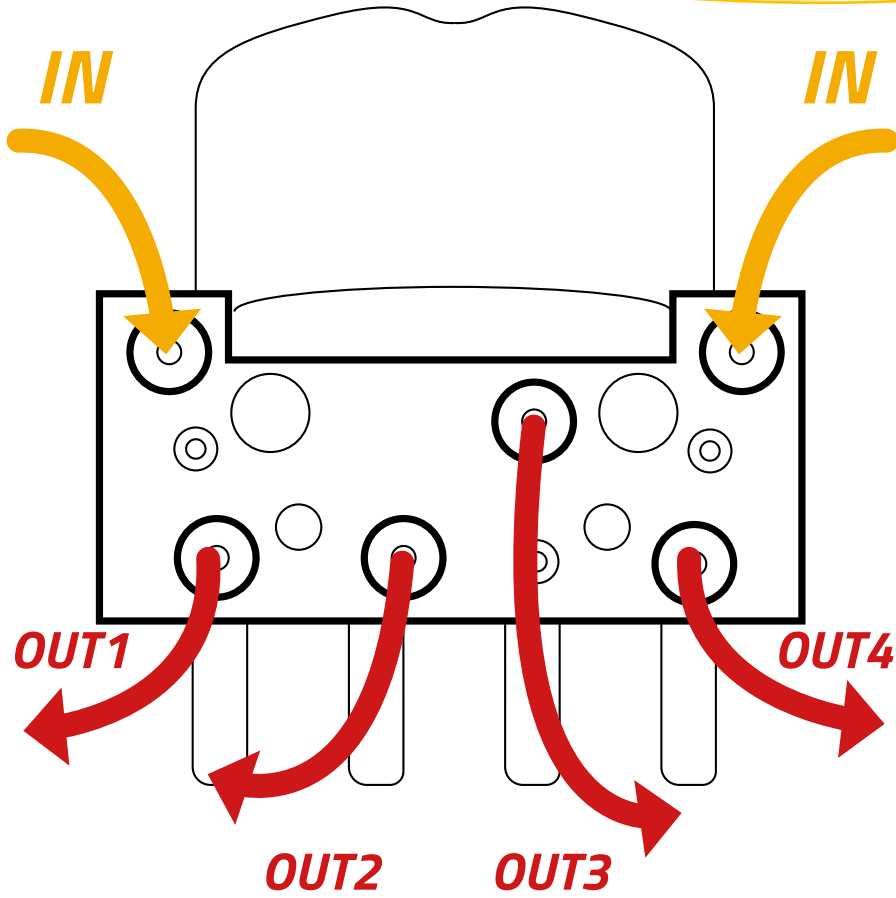



PG. 35

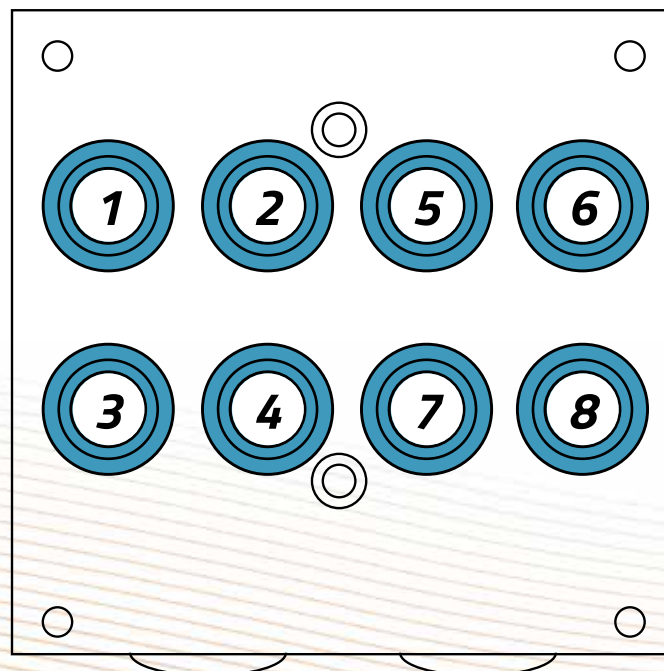
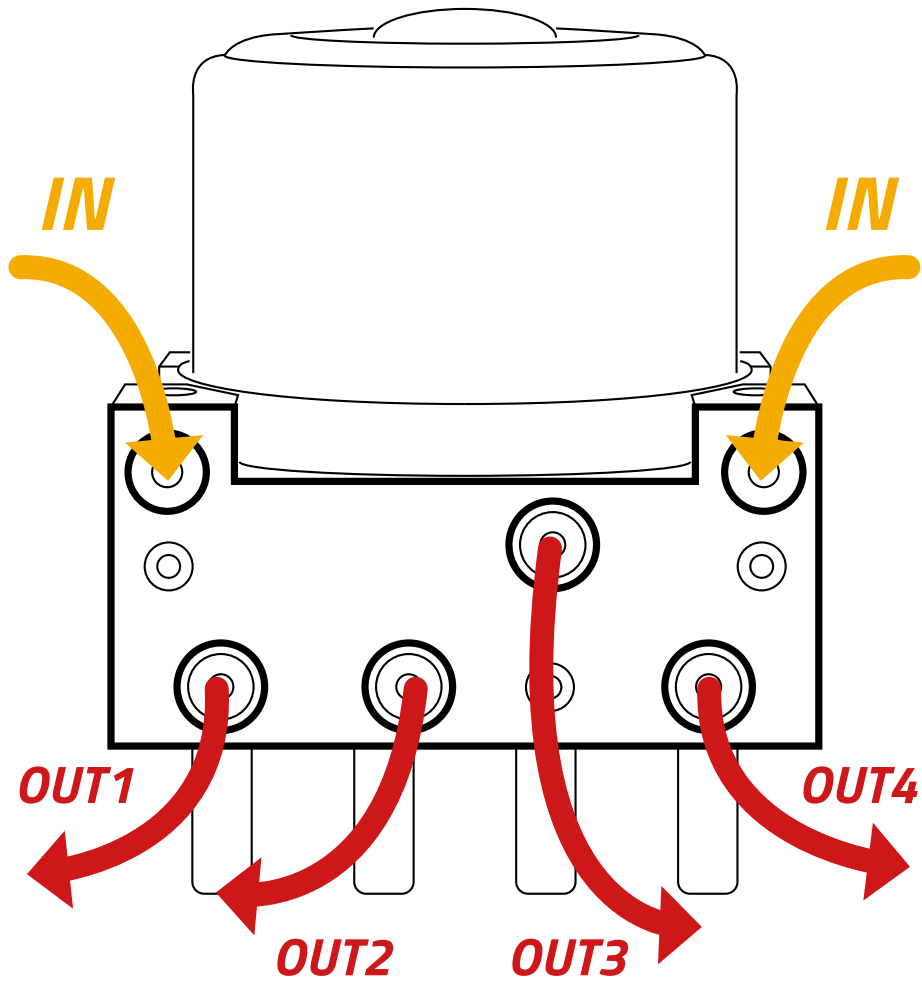

PG. 36

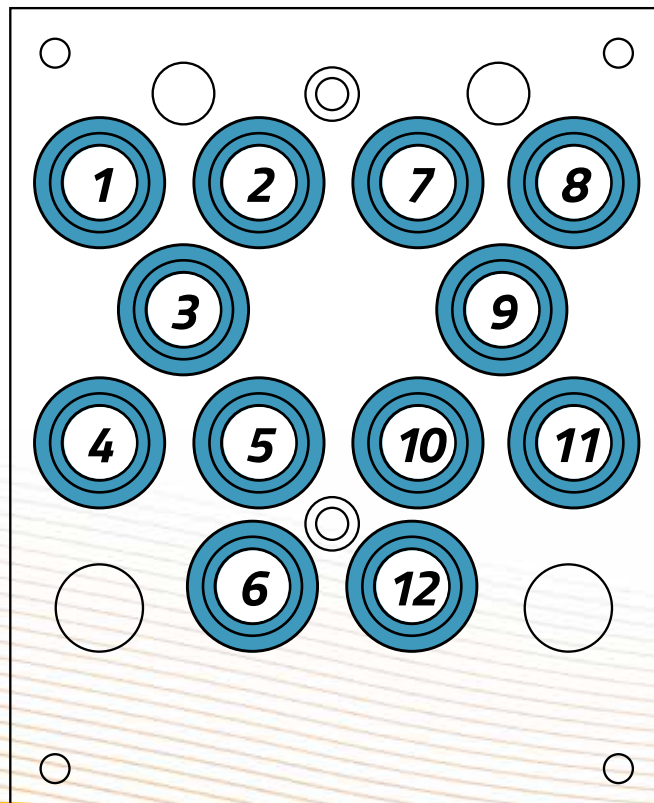
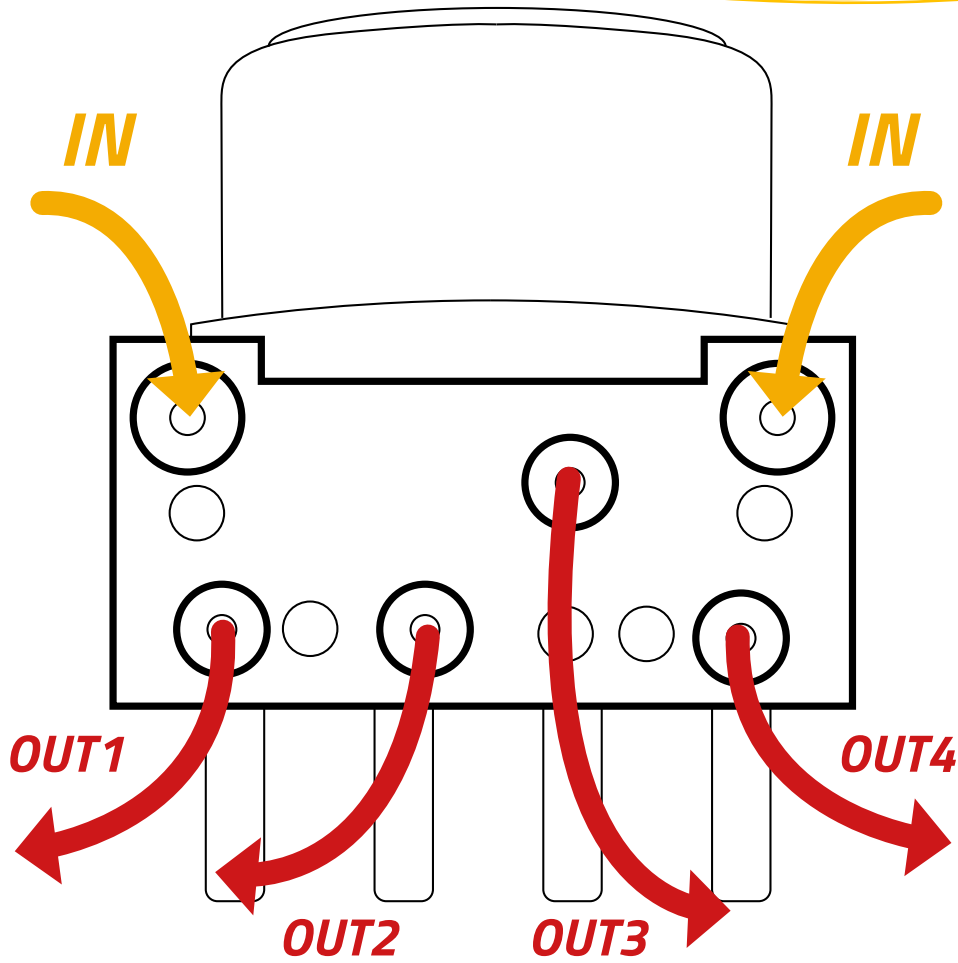



PG. 37

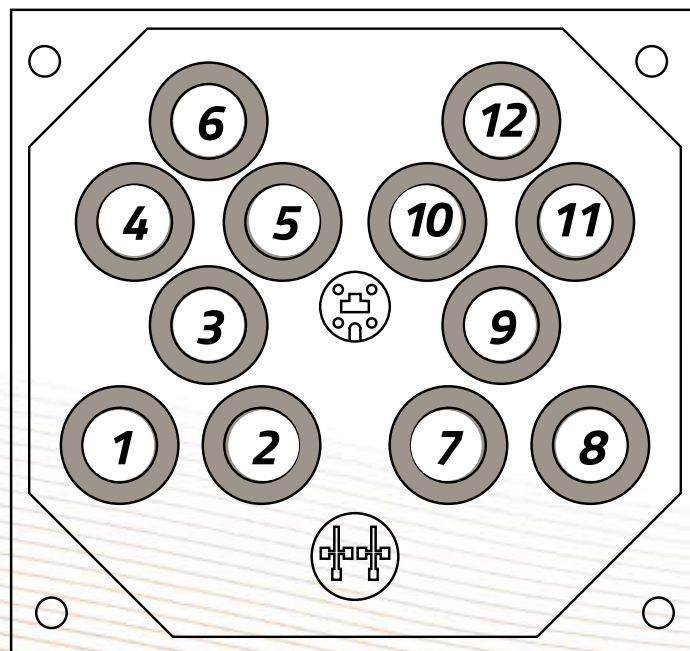
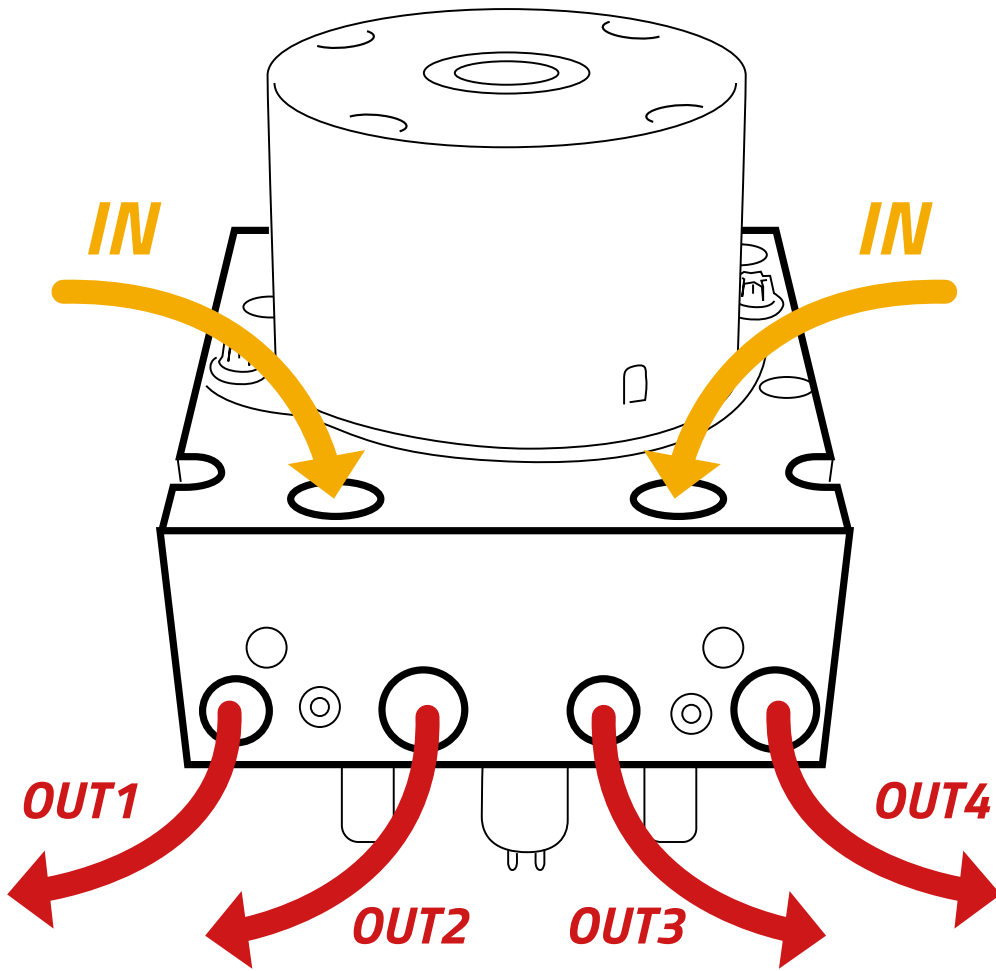



PG. 38

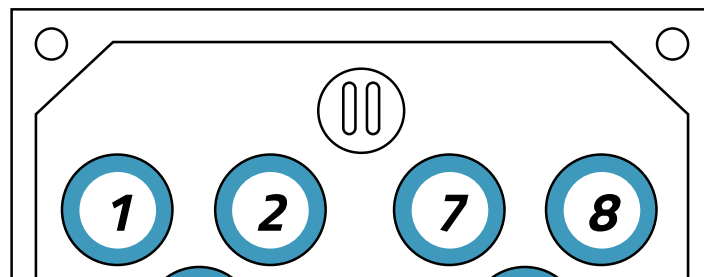
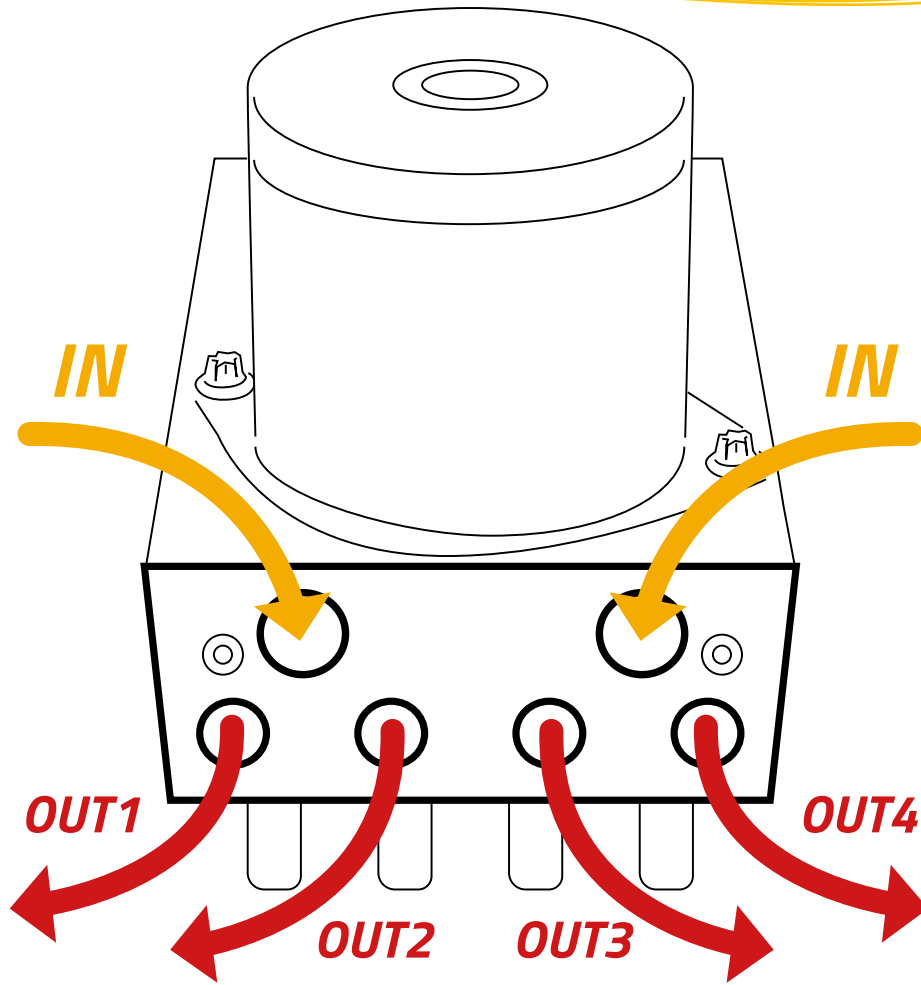

IN AGGIORNAMENTO

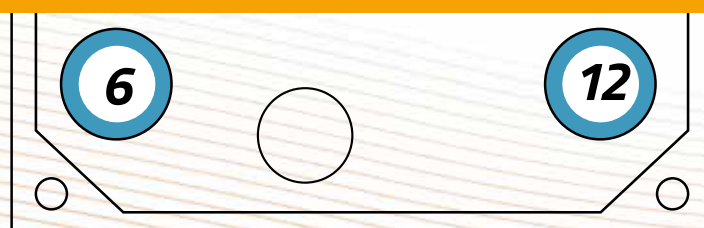

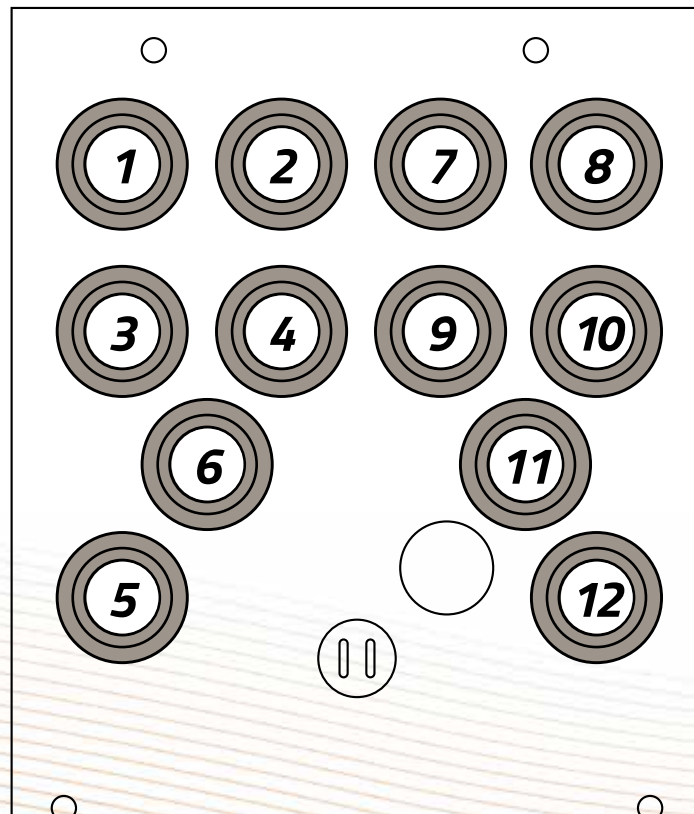
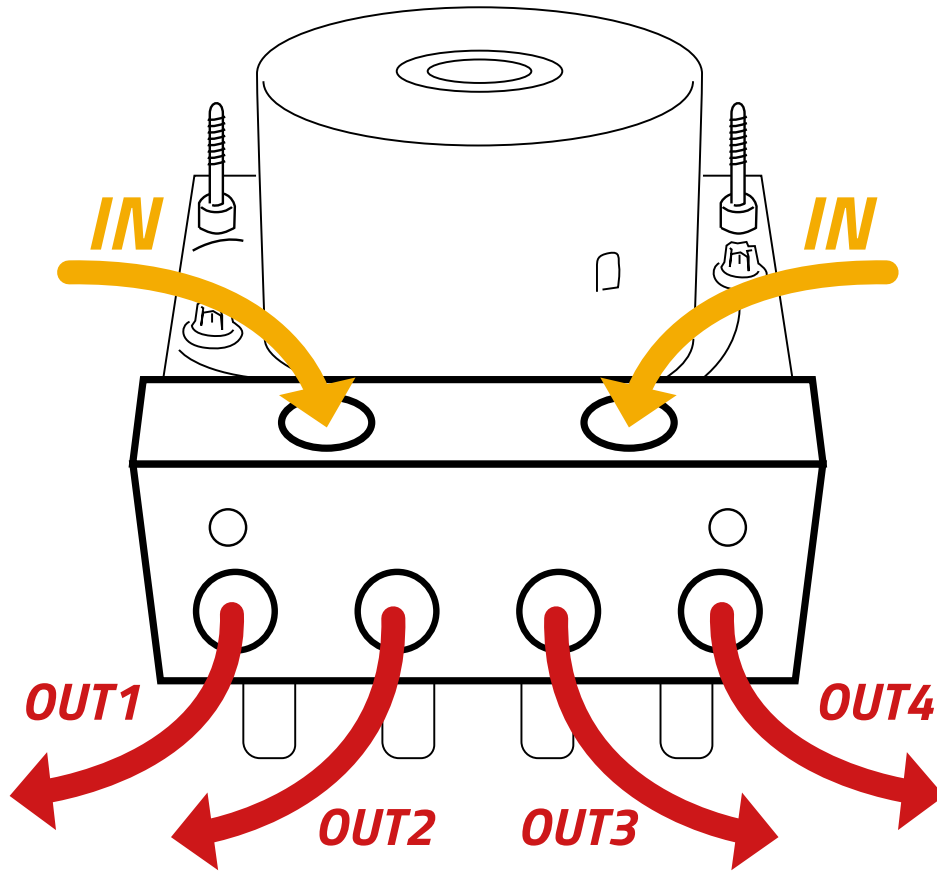



PG. 40

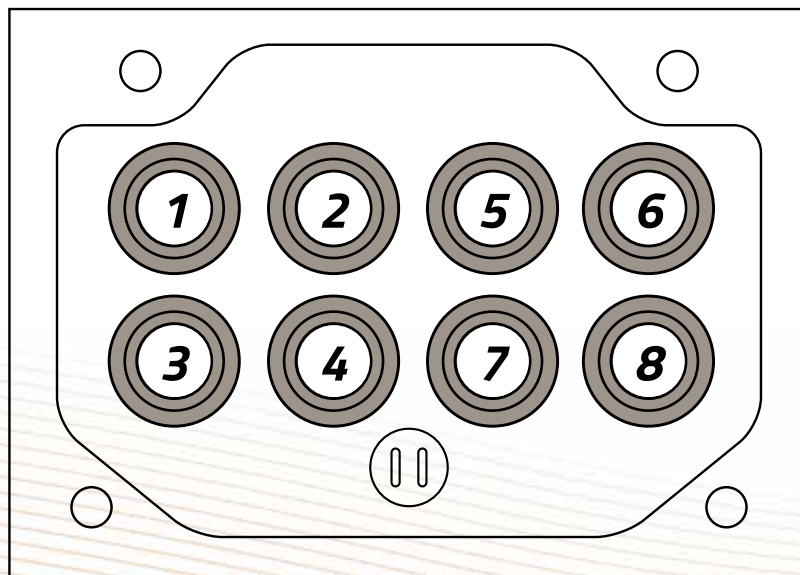
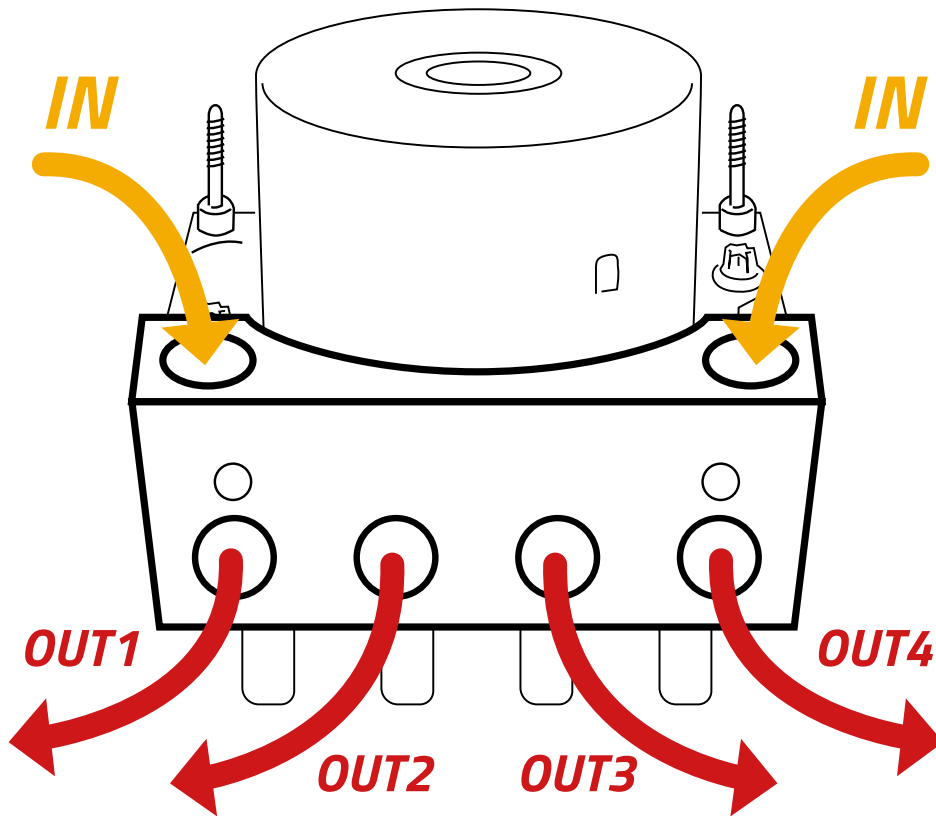



PG. 41

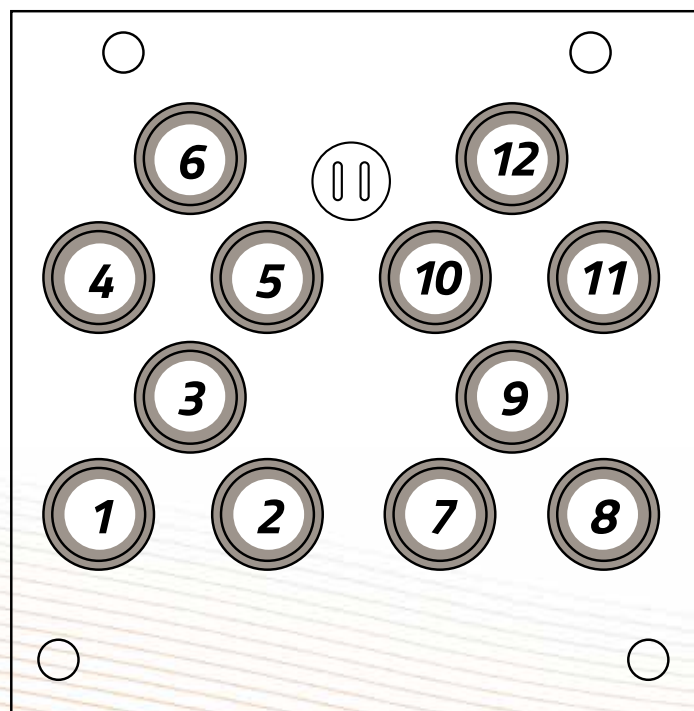
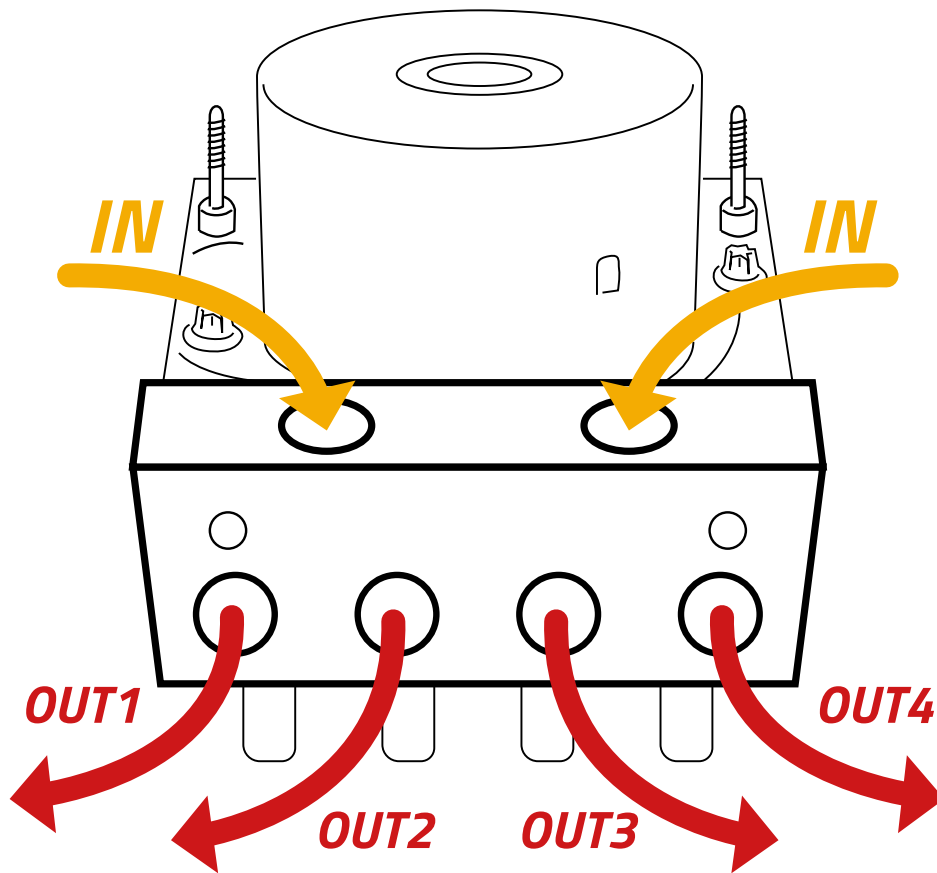



PG. 42

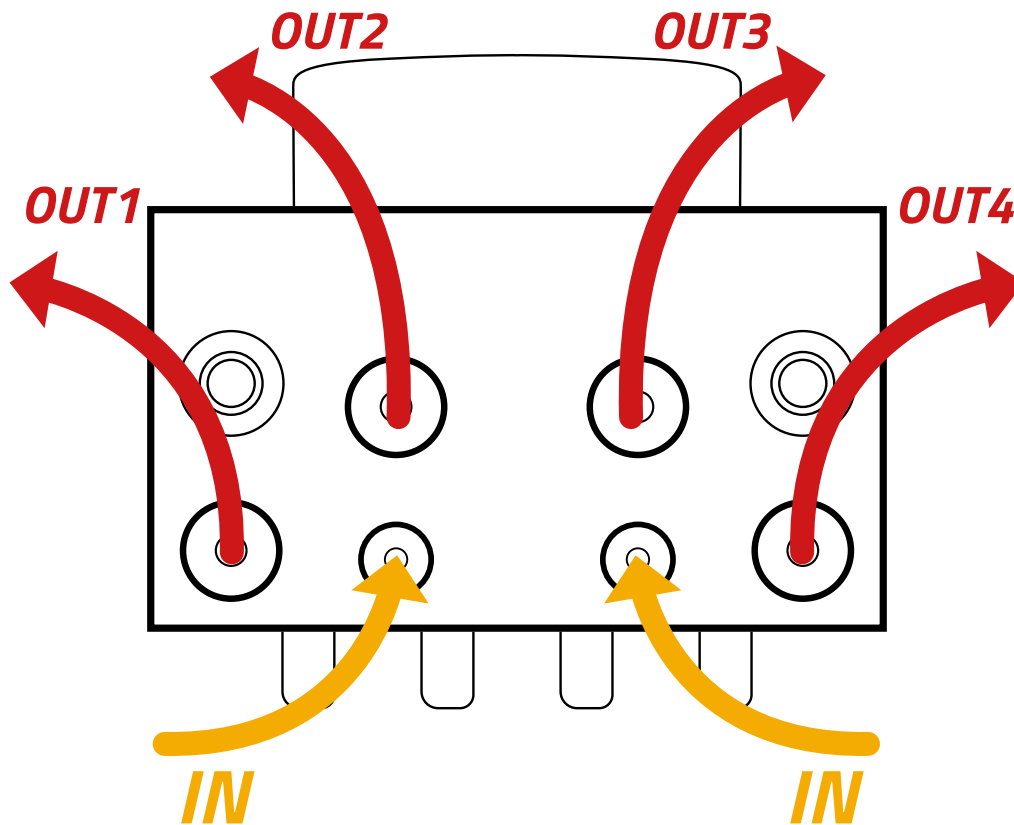

IN AGGIORNAMENTO



PG. 43

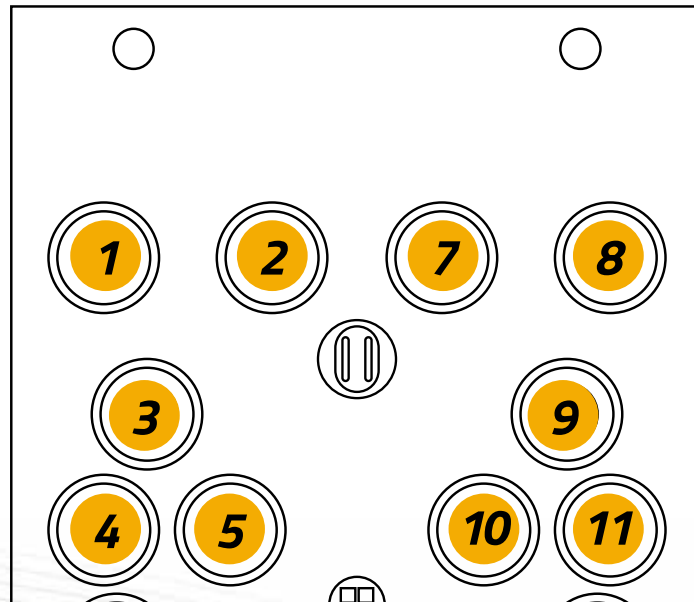
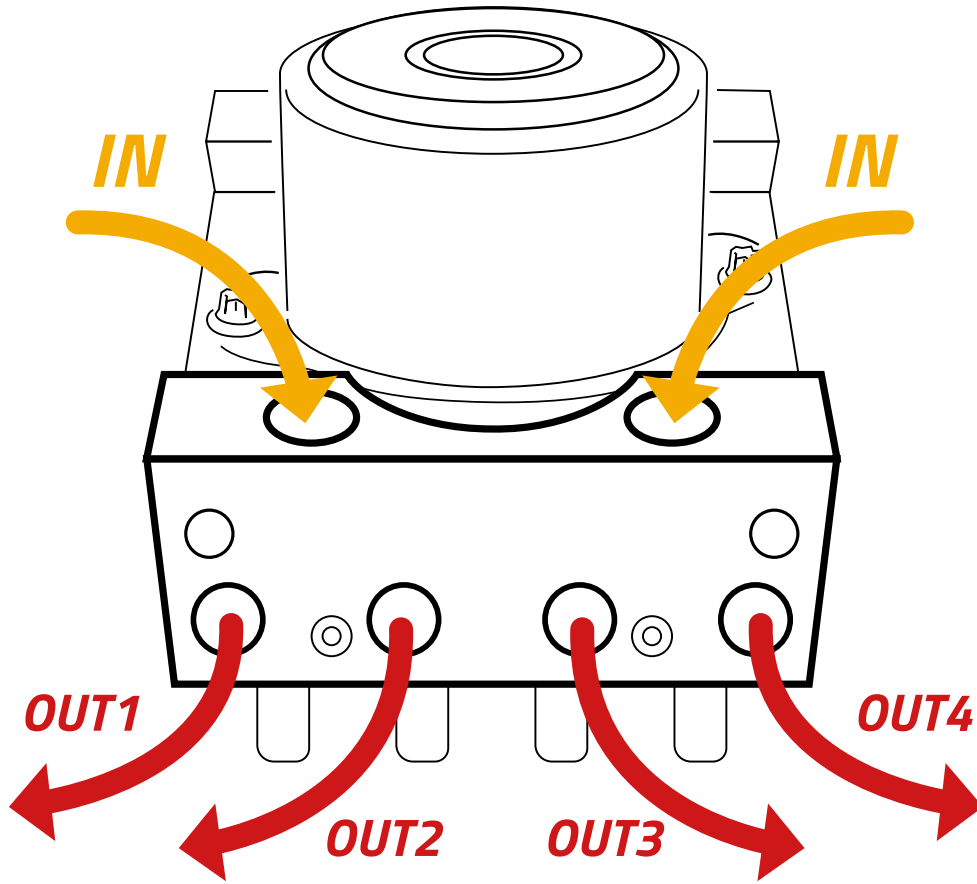

IN AGGIORNAMENTO



IN AGGIORNAMENTO

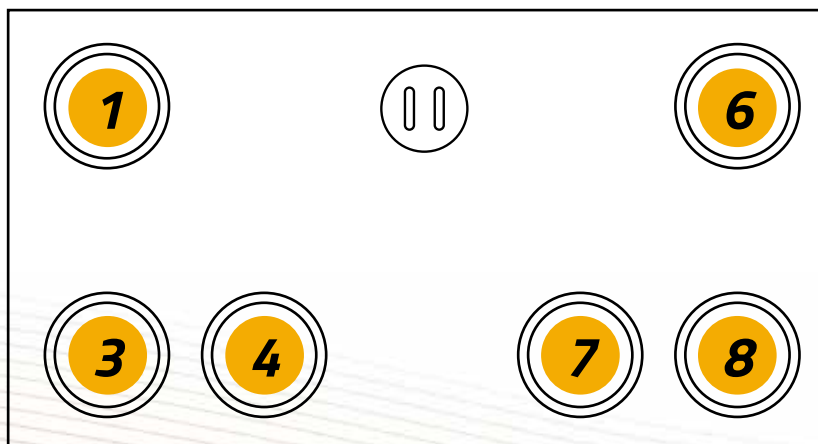



PG. 45

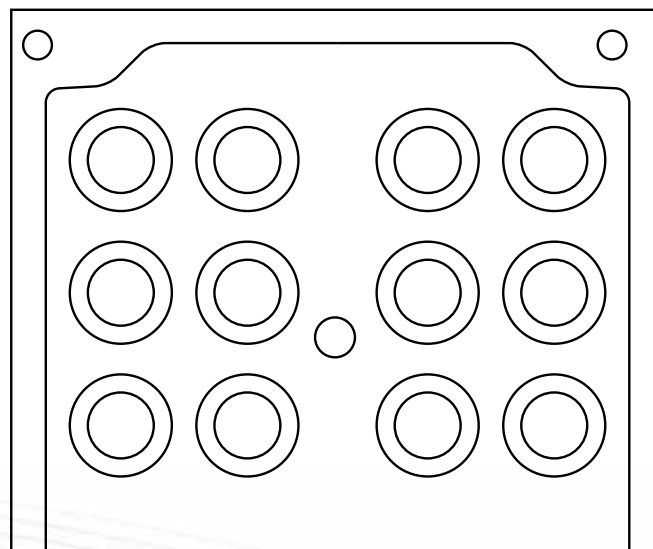
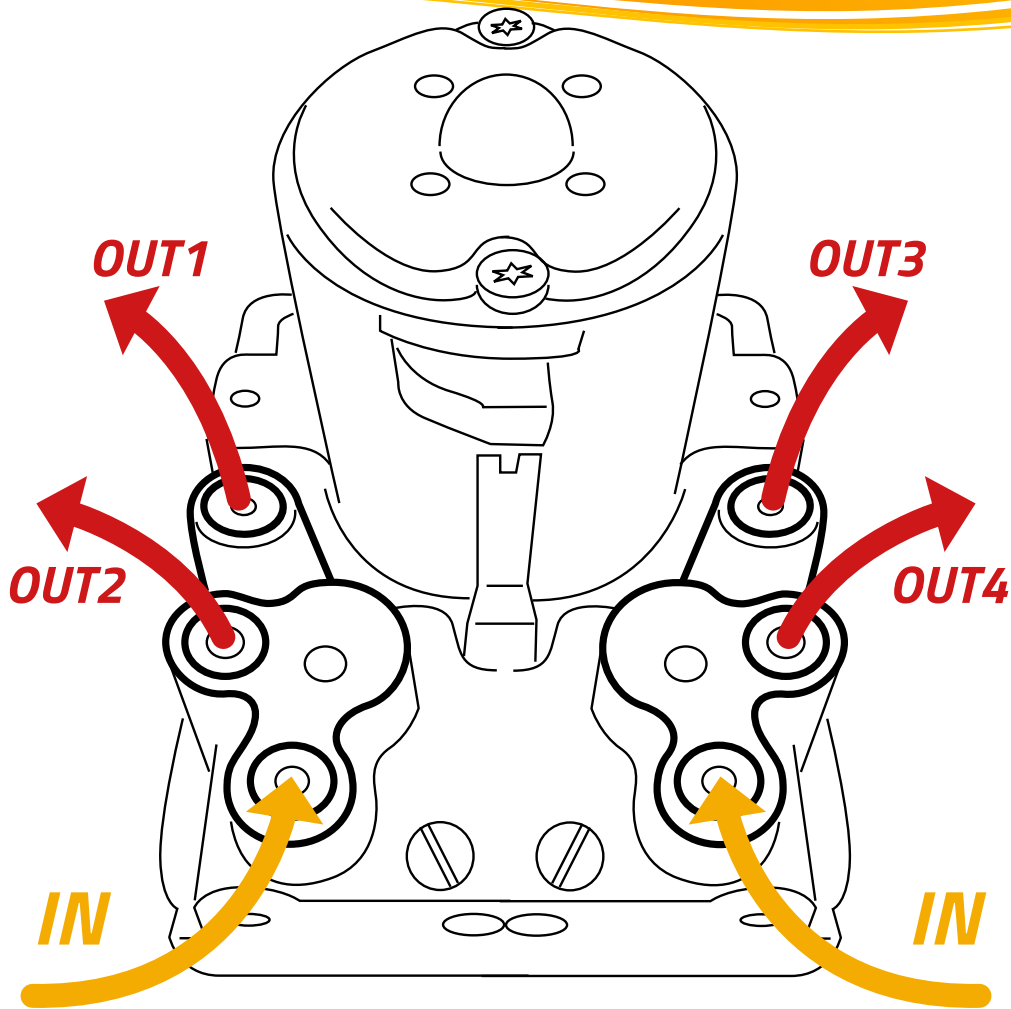

IN AGGIORNAMENTO

PG. 46

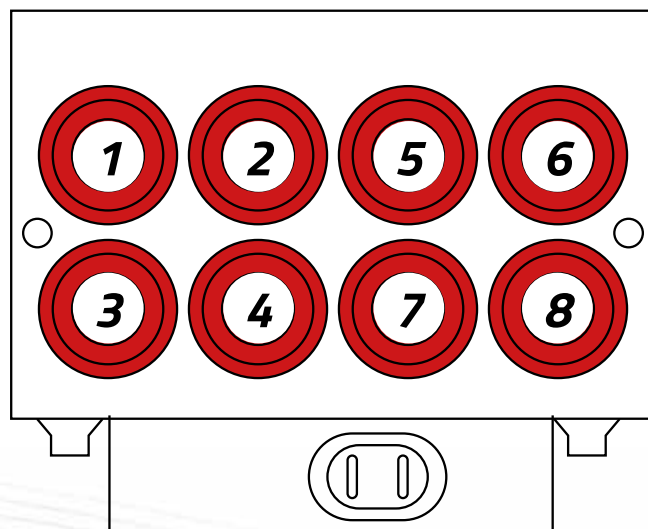
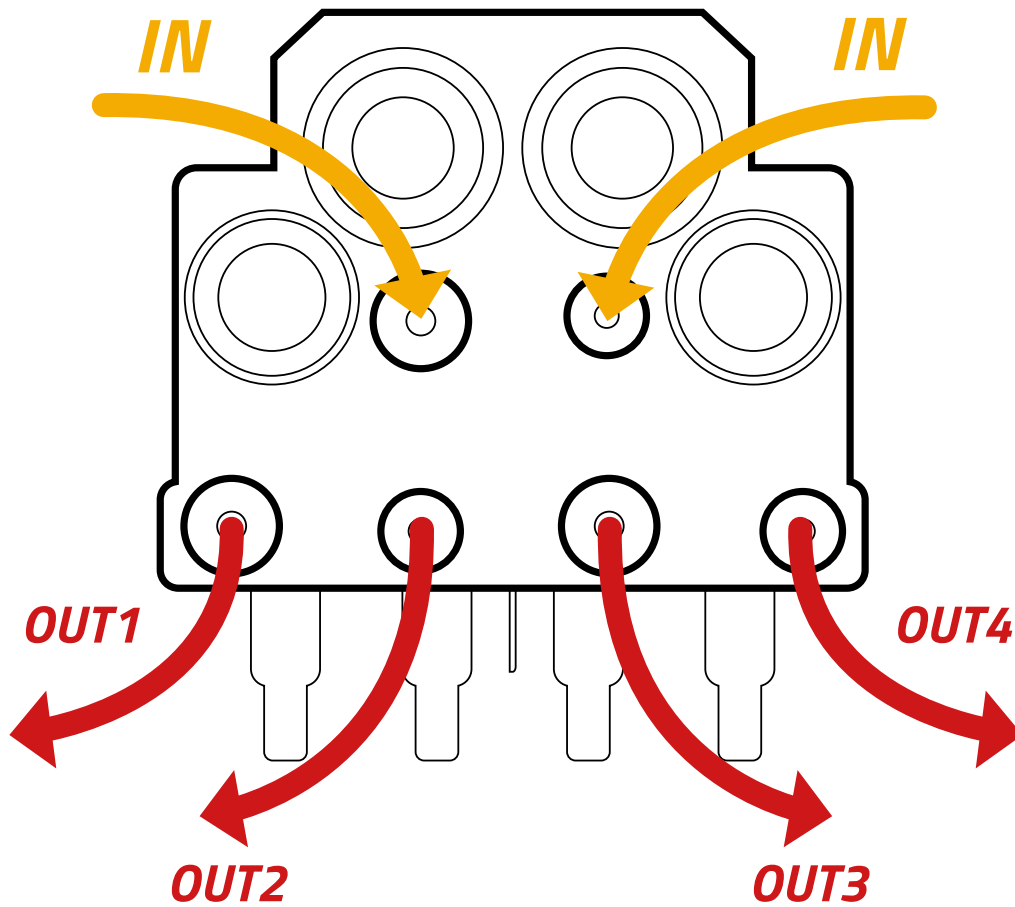

IN AGGIORNAMENTO



PG. 47

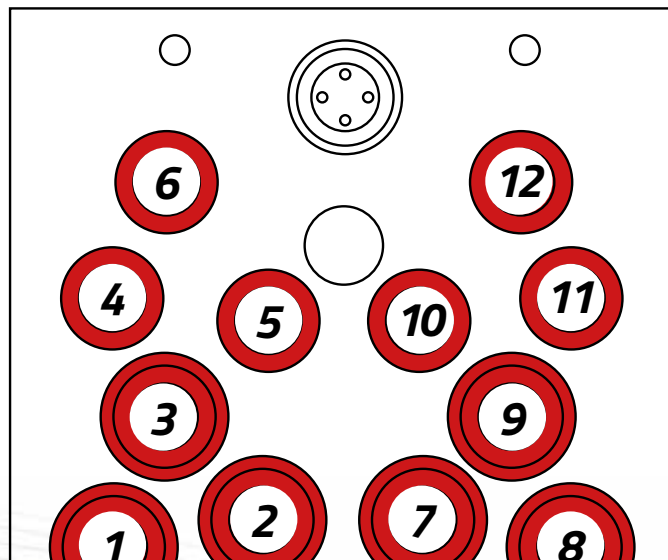
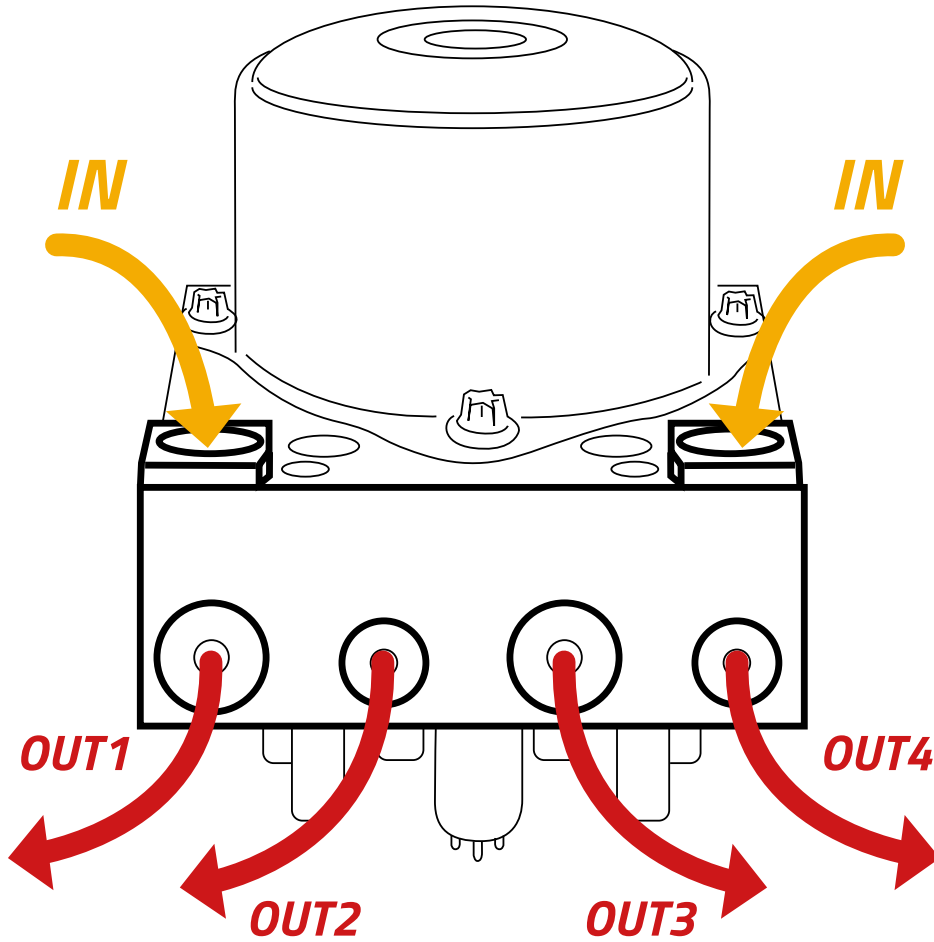

IN AGGIORNAMENTO



PG. 48

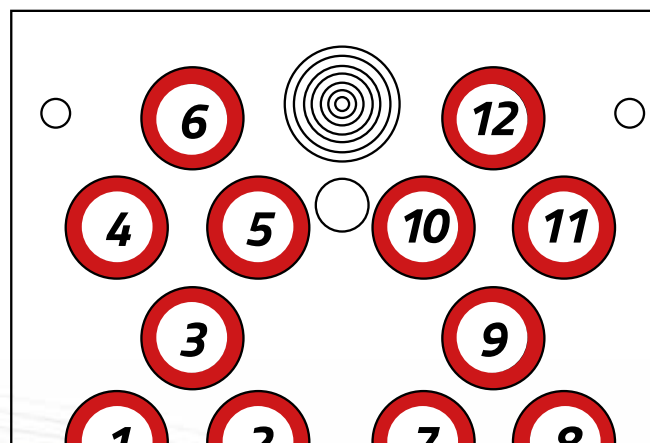
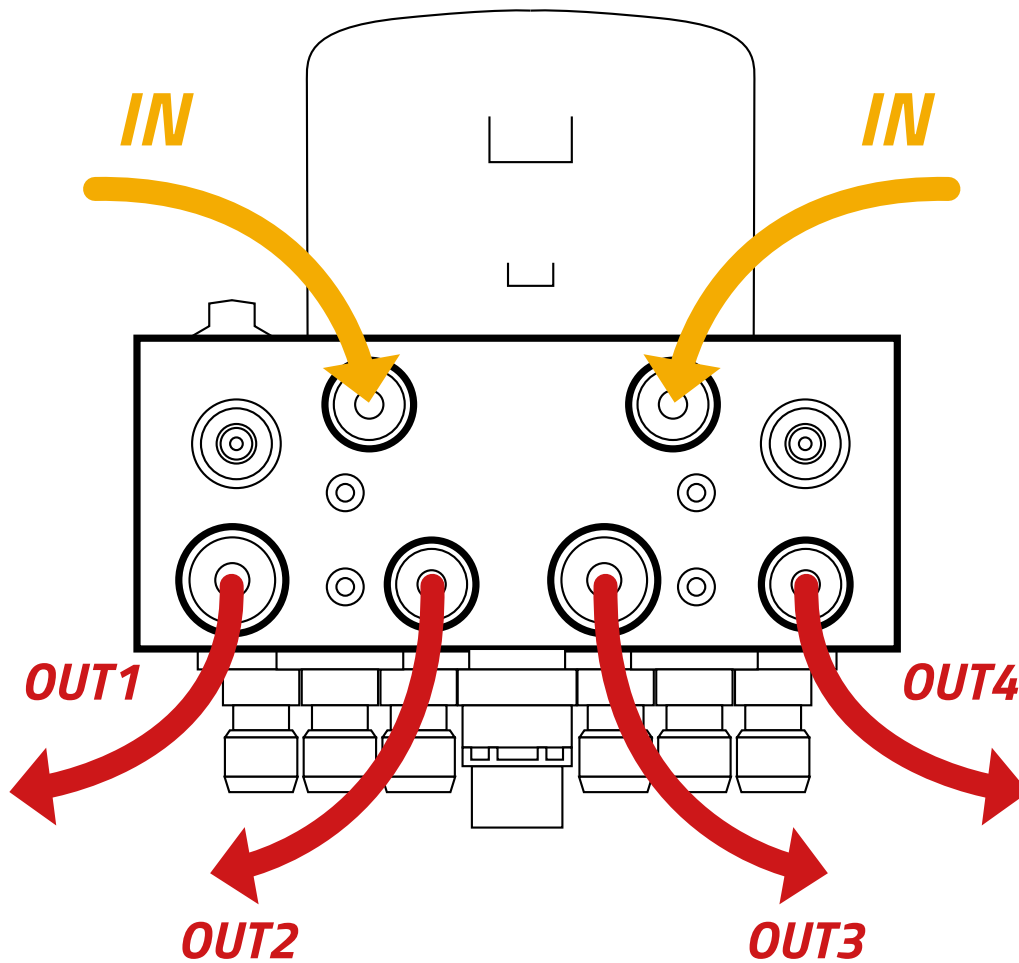

IN AGGIORNAMENTO



PG. 49

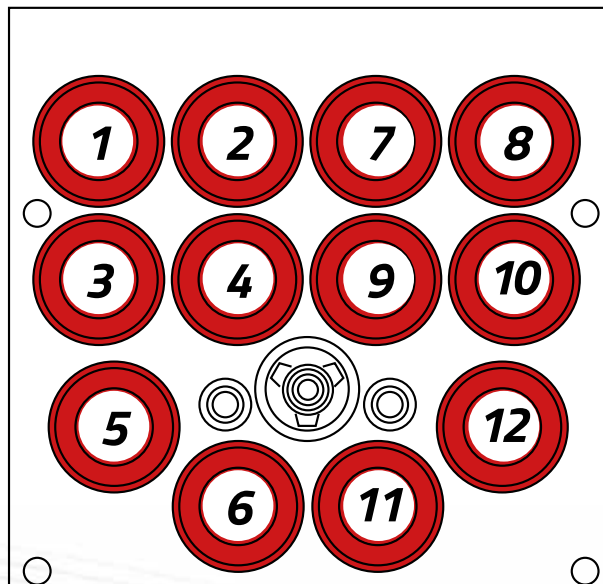
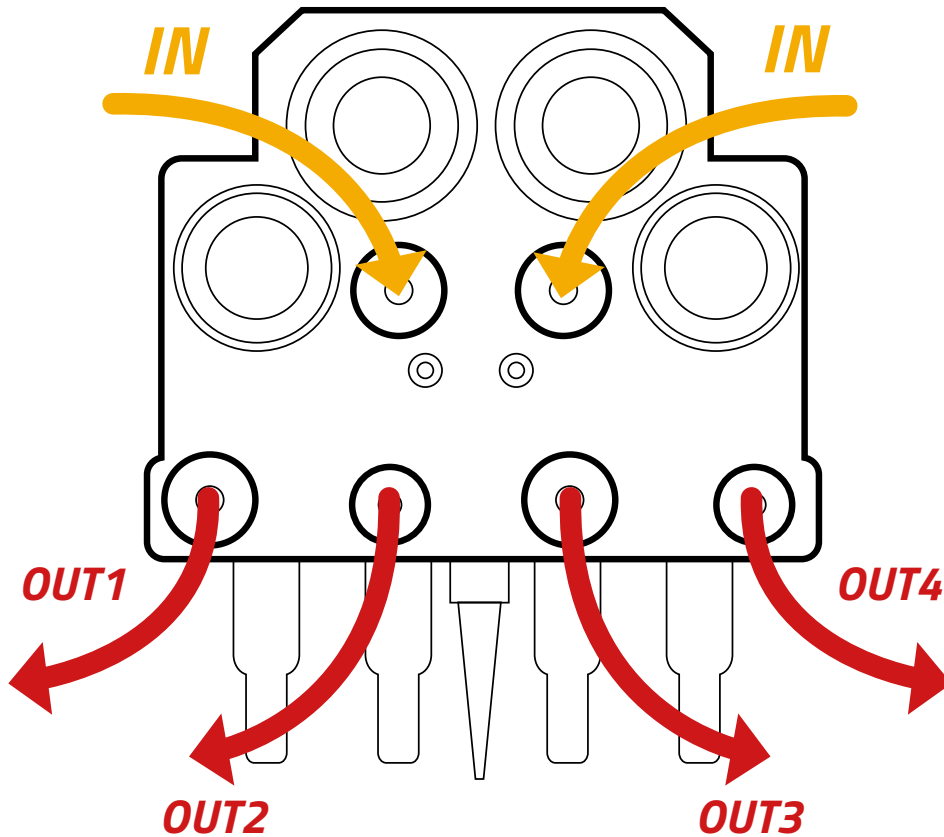

IN AGGIORNAMENTO

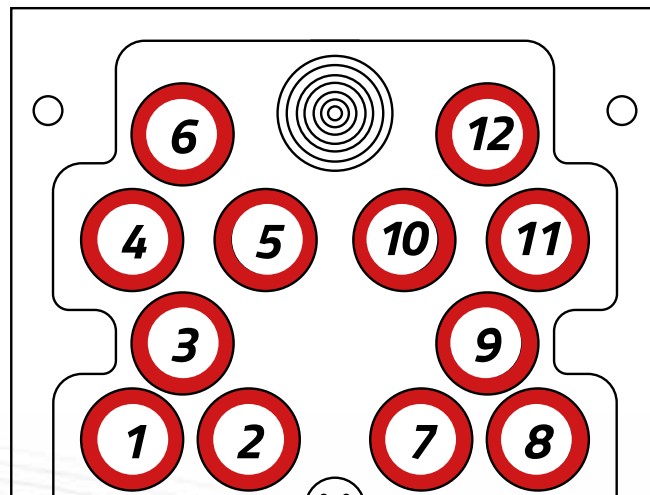
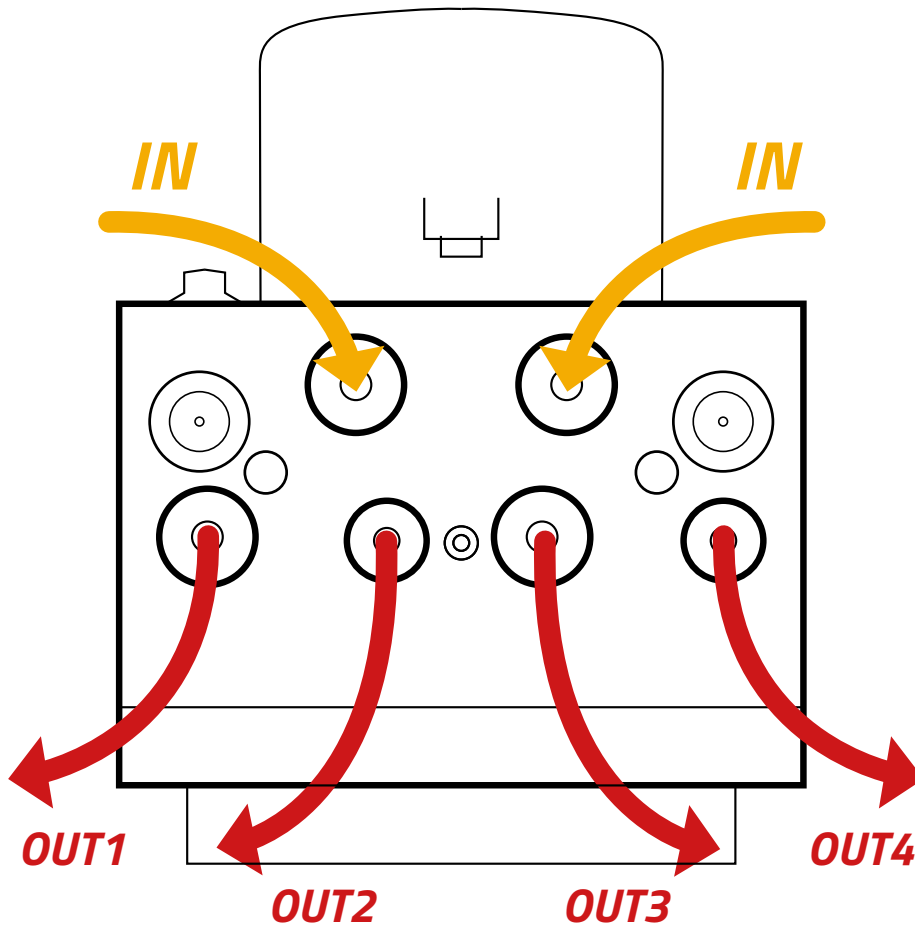

IN AGGIORNAMENTO



BIKE

PG. 51





PG. 52

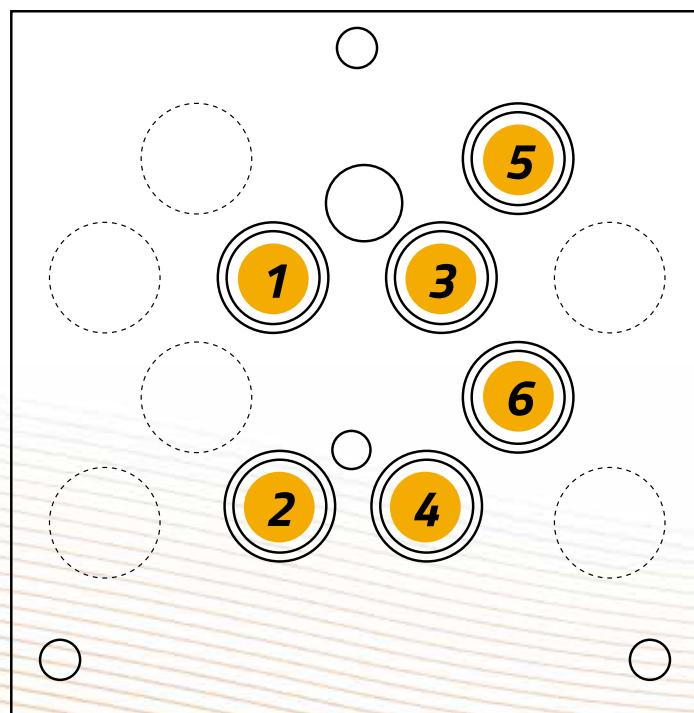
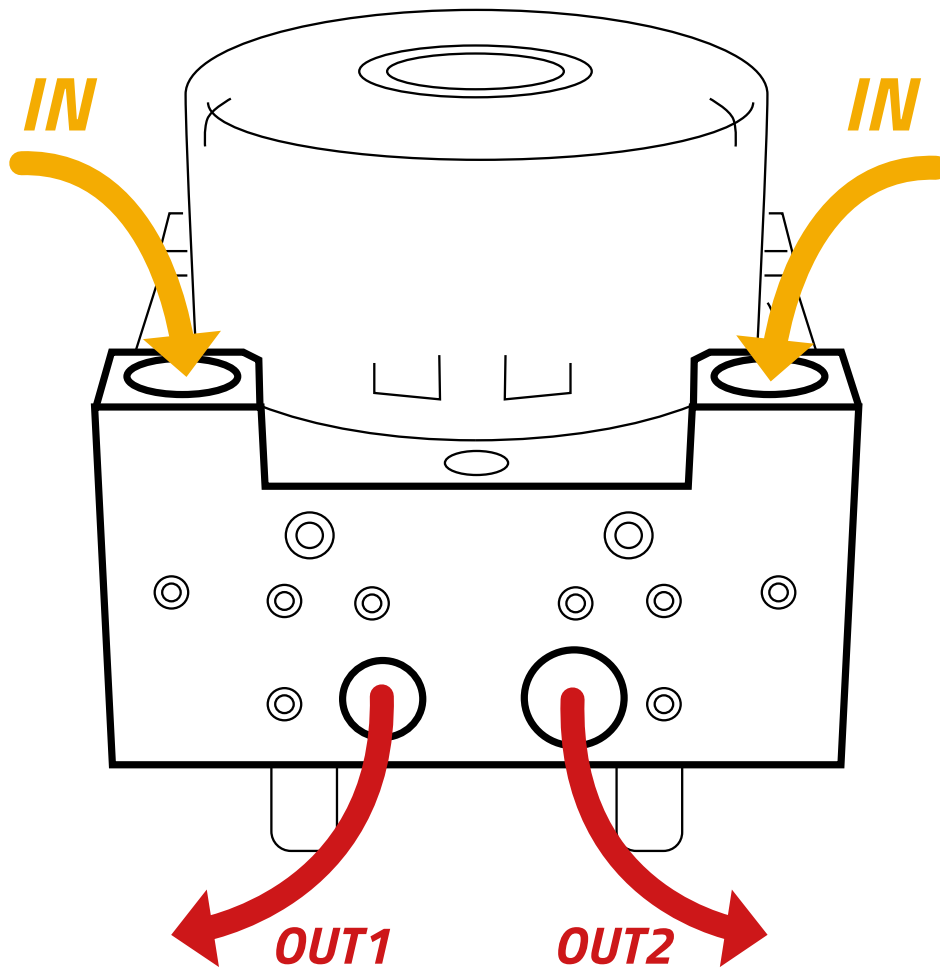



PG. 53

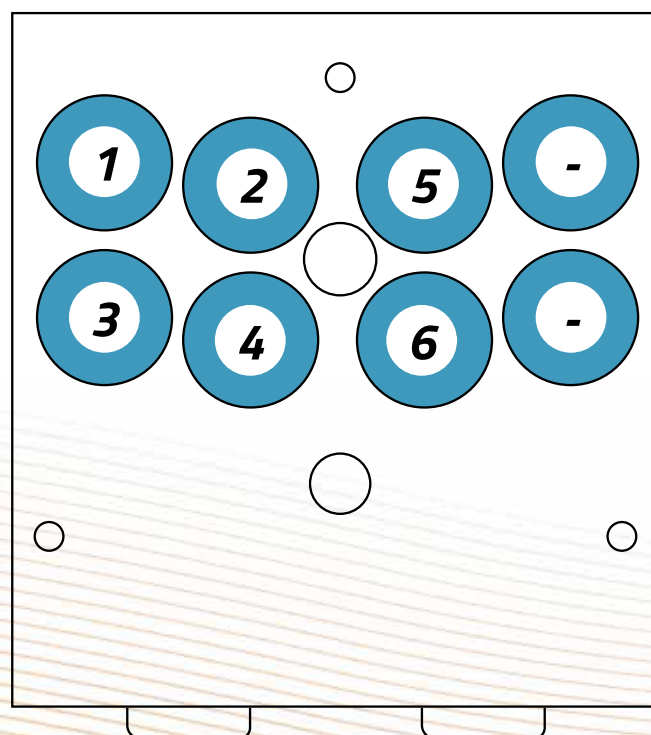
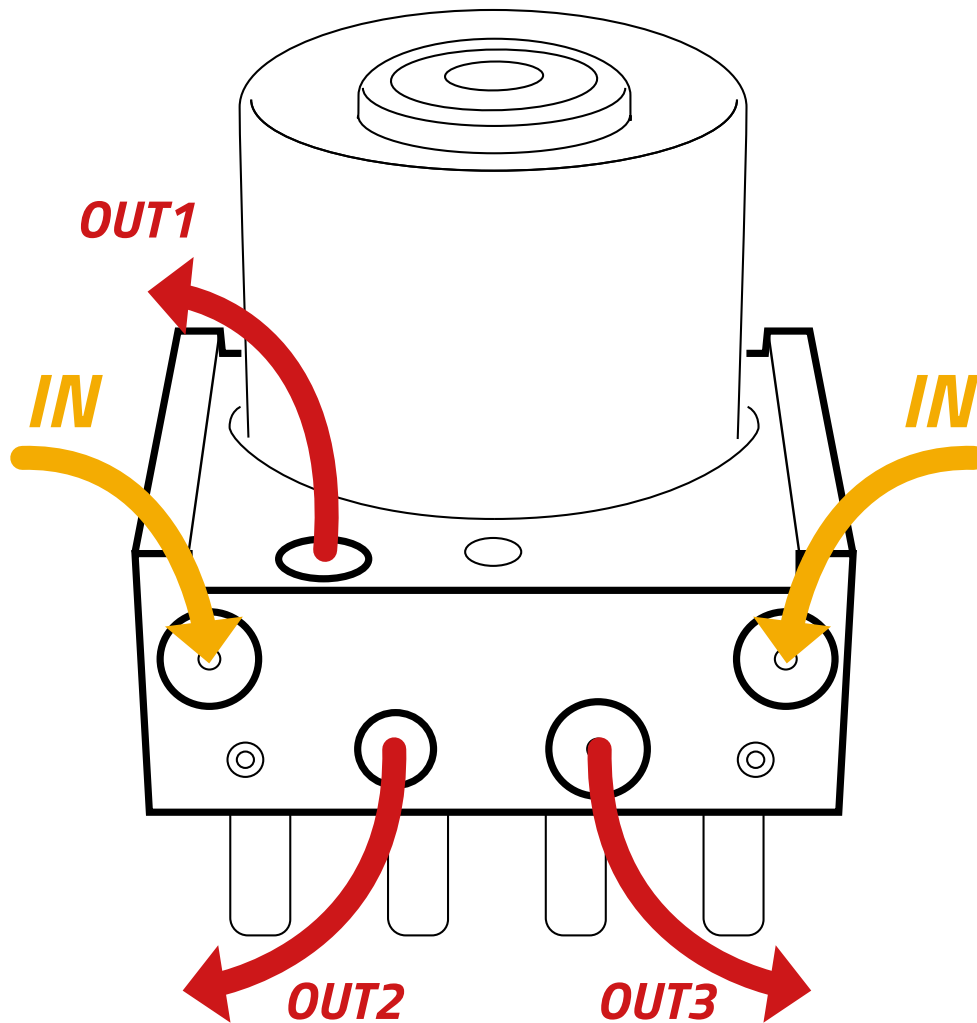



PG. 54

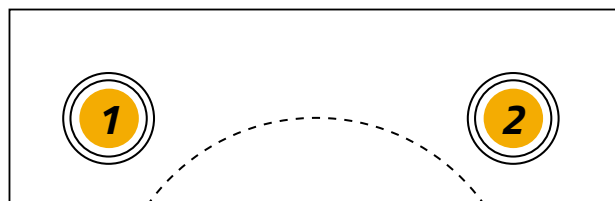
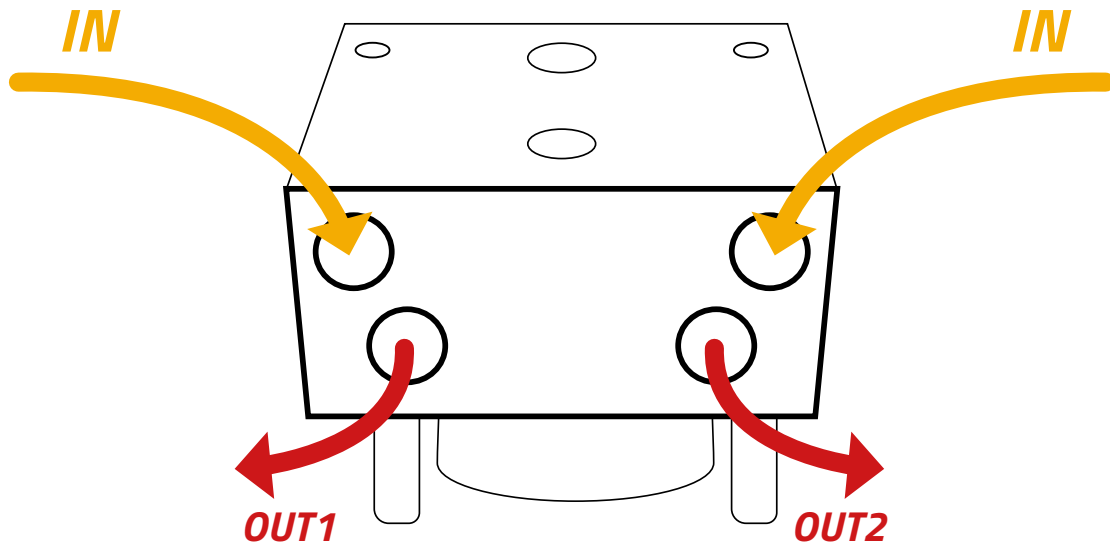
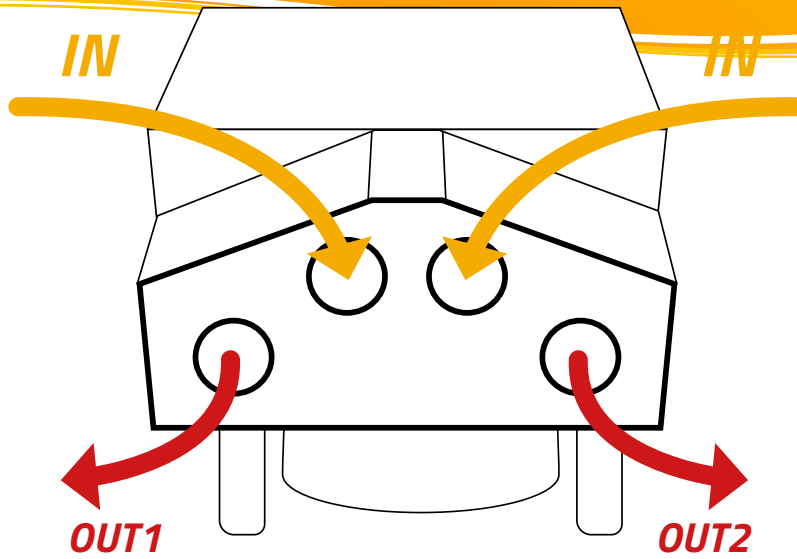

IN AGGIORNAMENTO

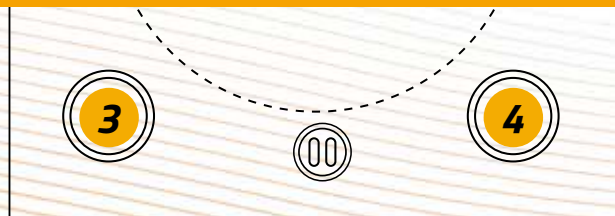

PG. 55

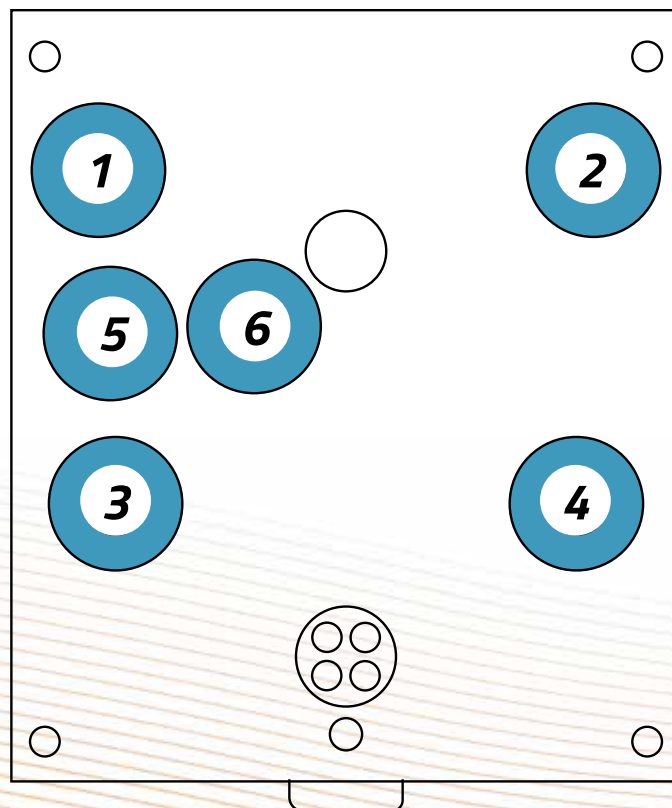
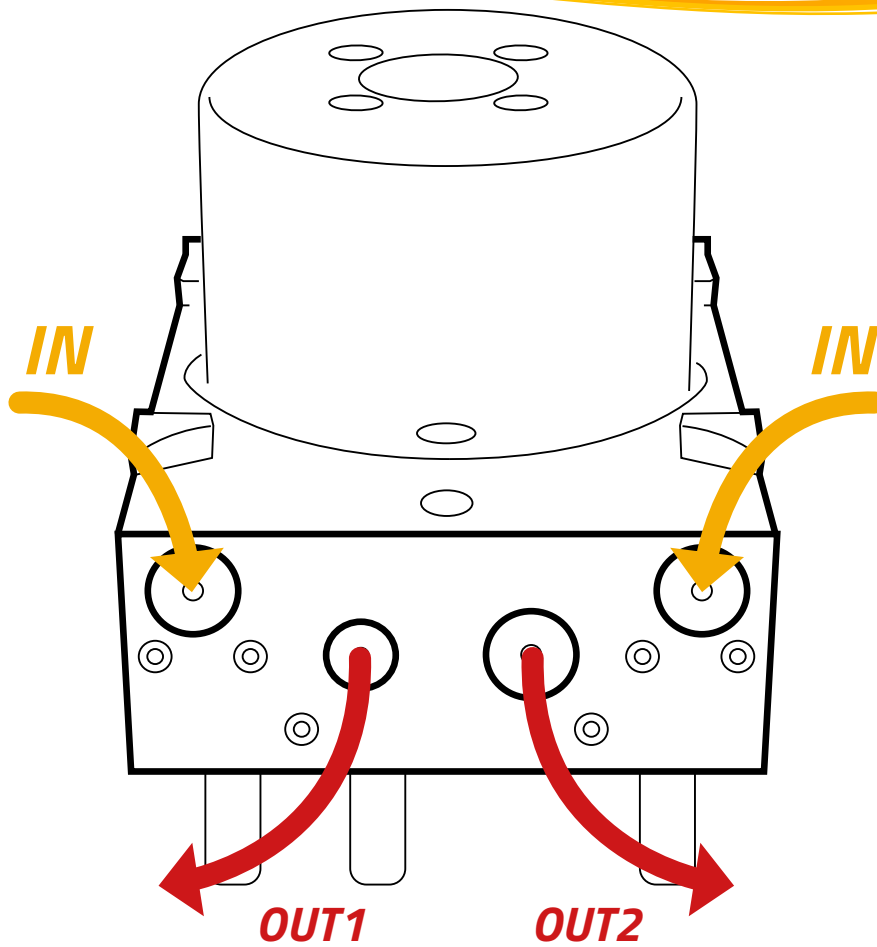



PG. 56

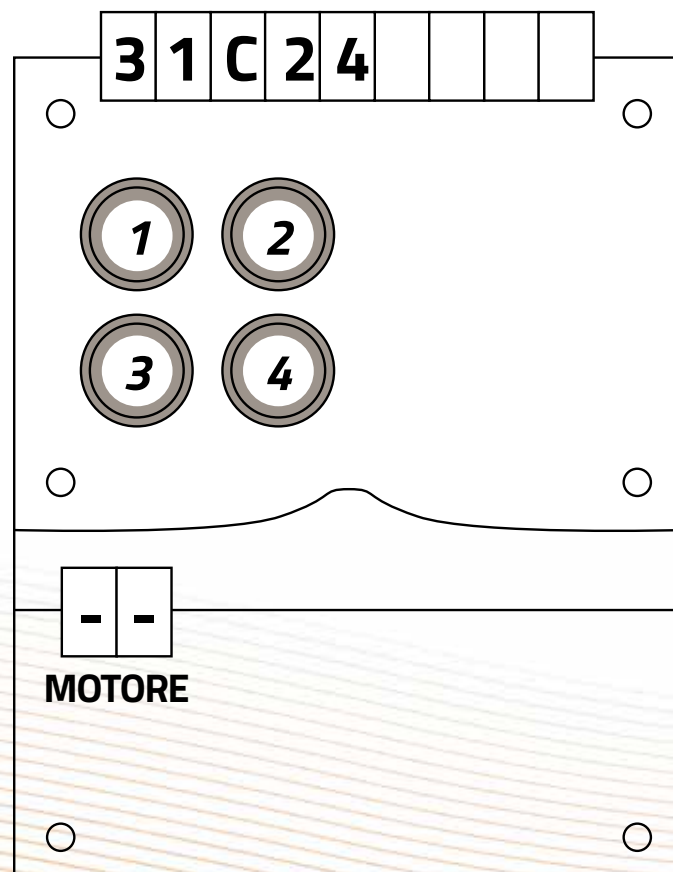
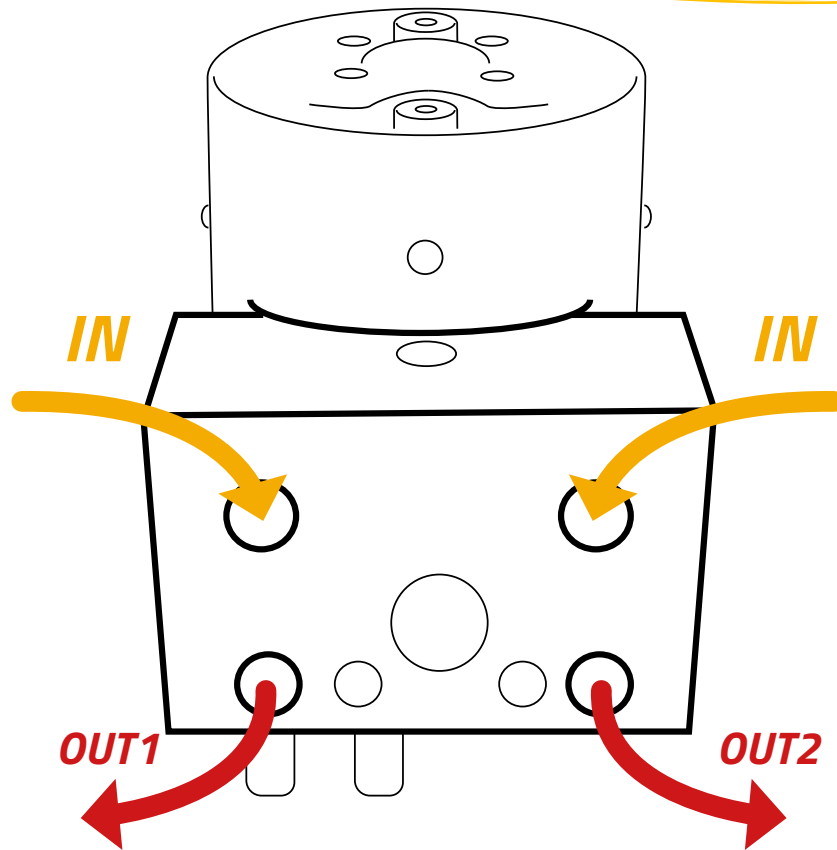



PG. 57

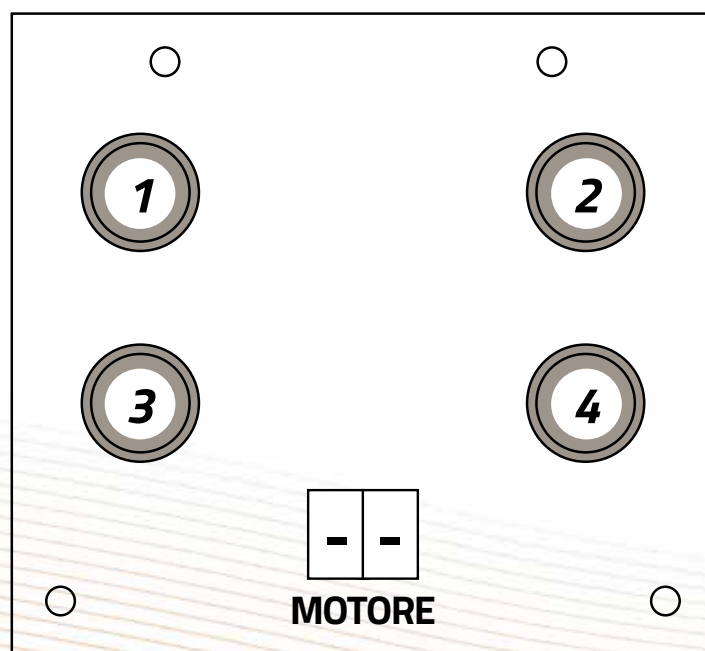
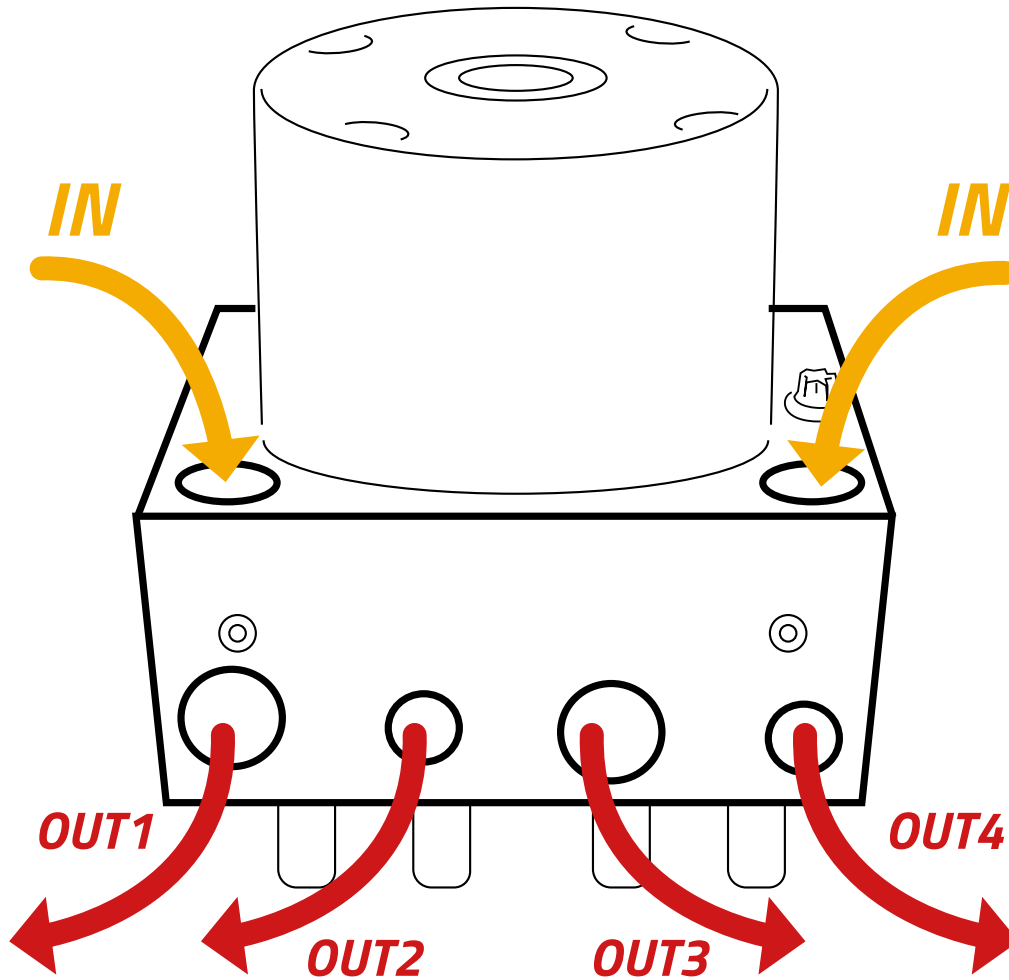



PG. 58

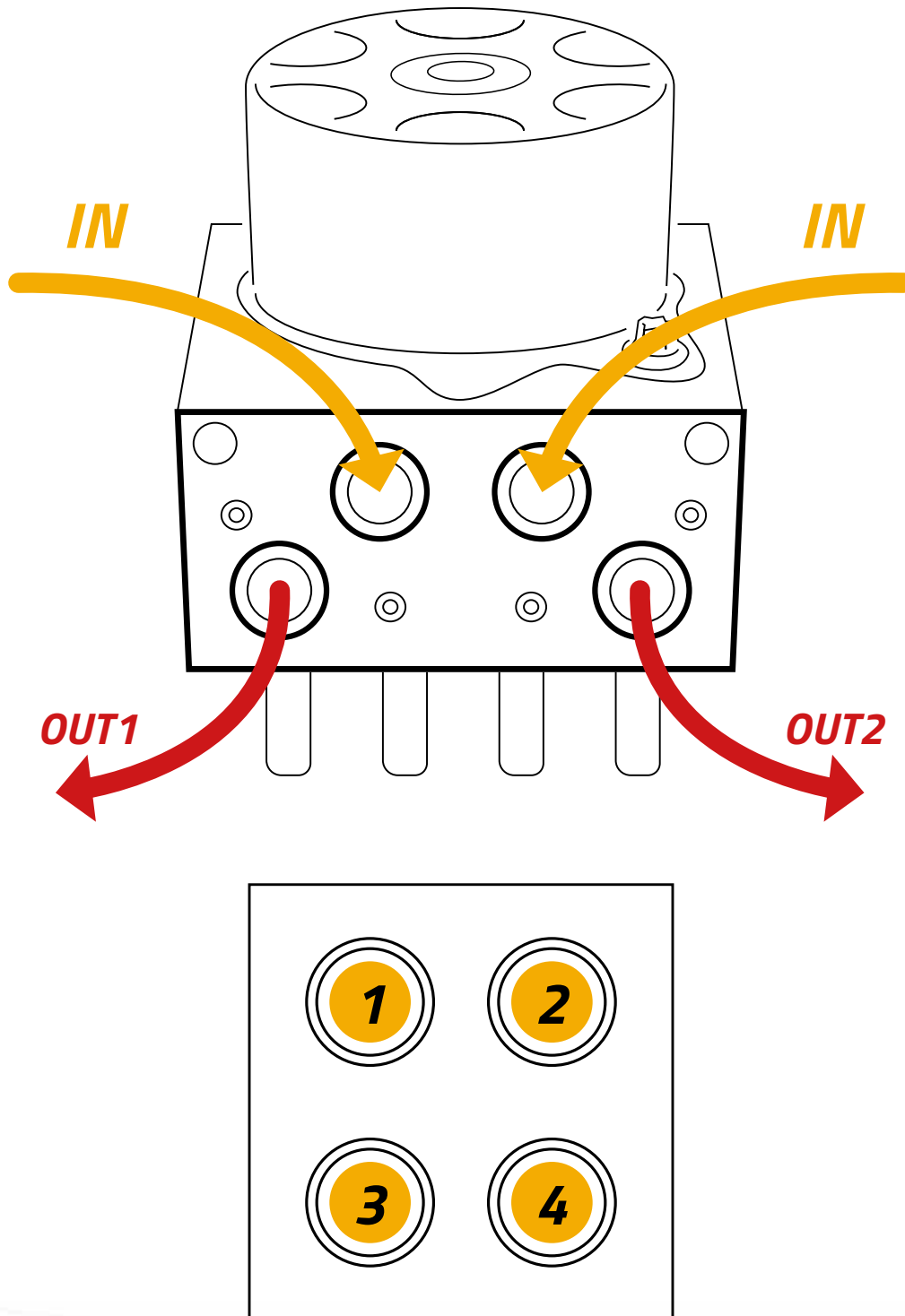

IN AGGIORNAMENTO



PG. 59

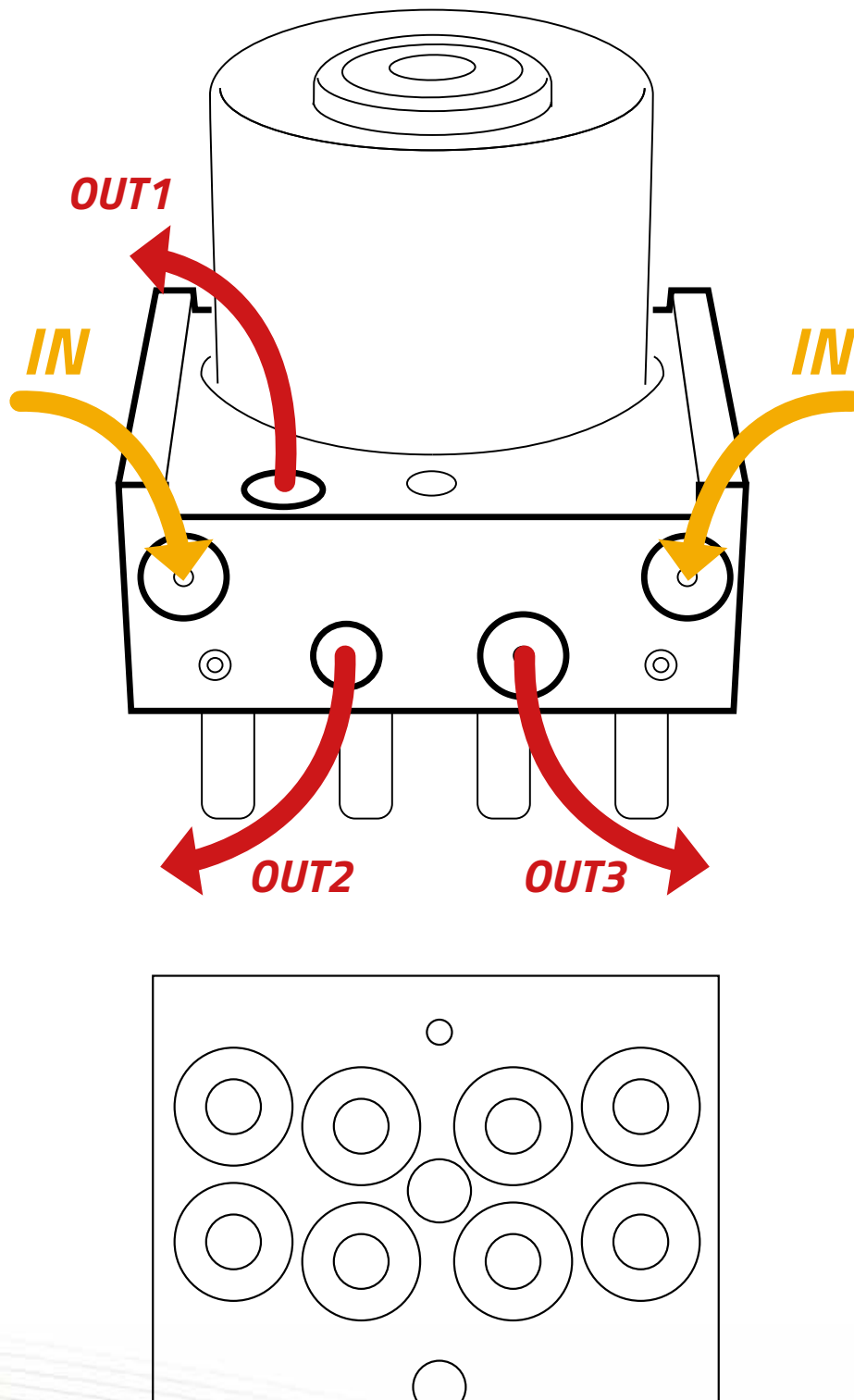

IN AGGIORNAMENTO



PG. 60

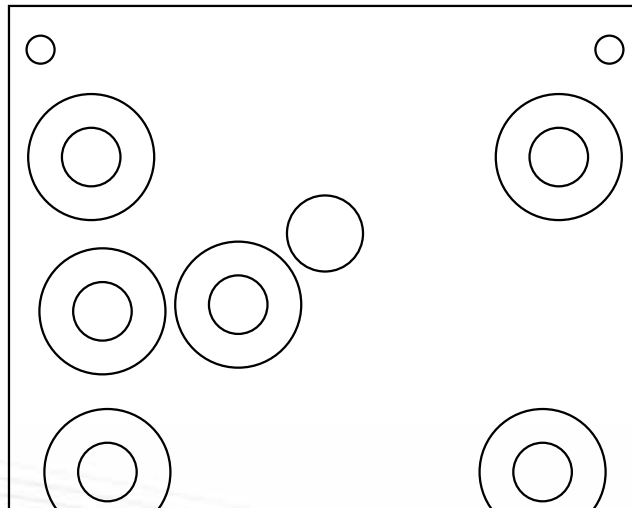
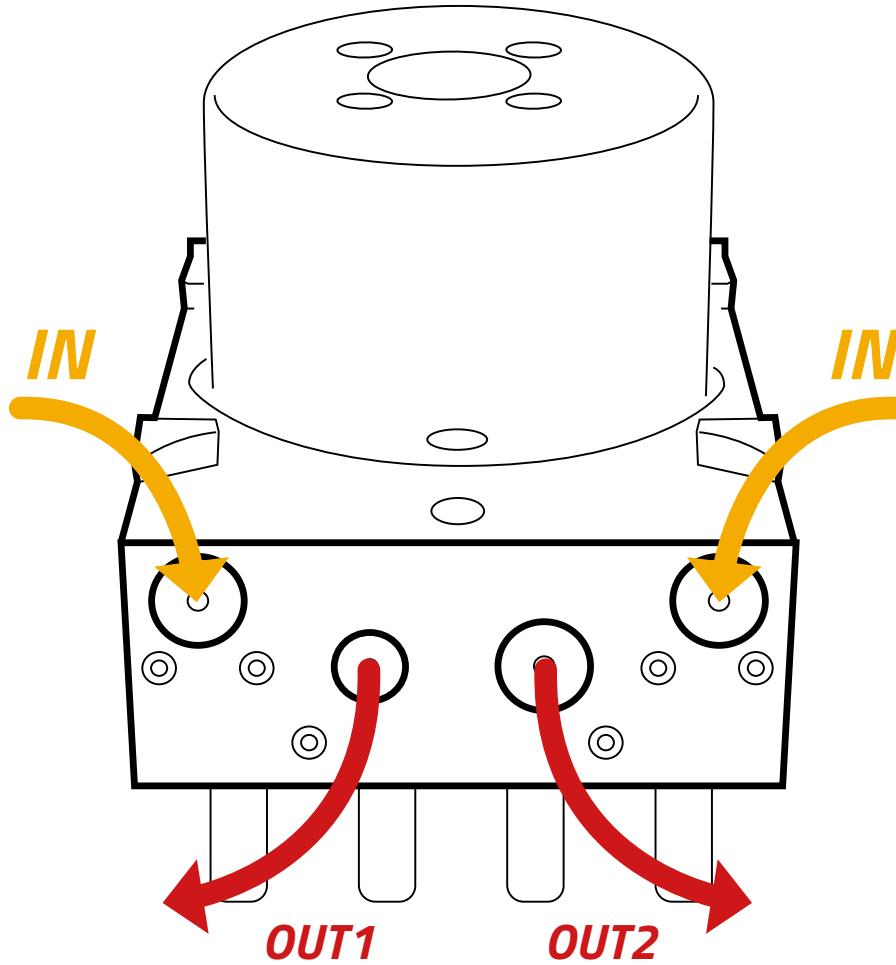

IN AGGIORNAMENTO



PG. 61

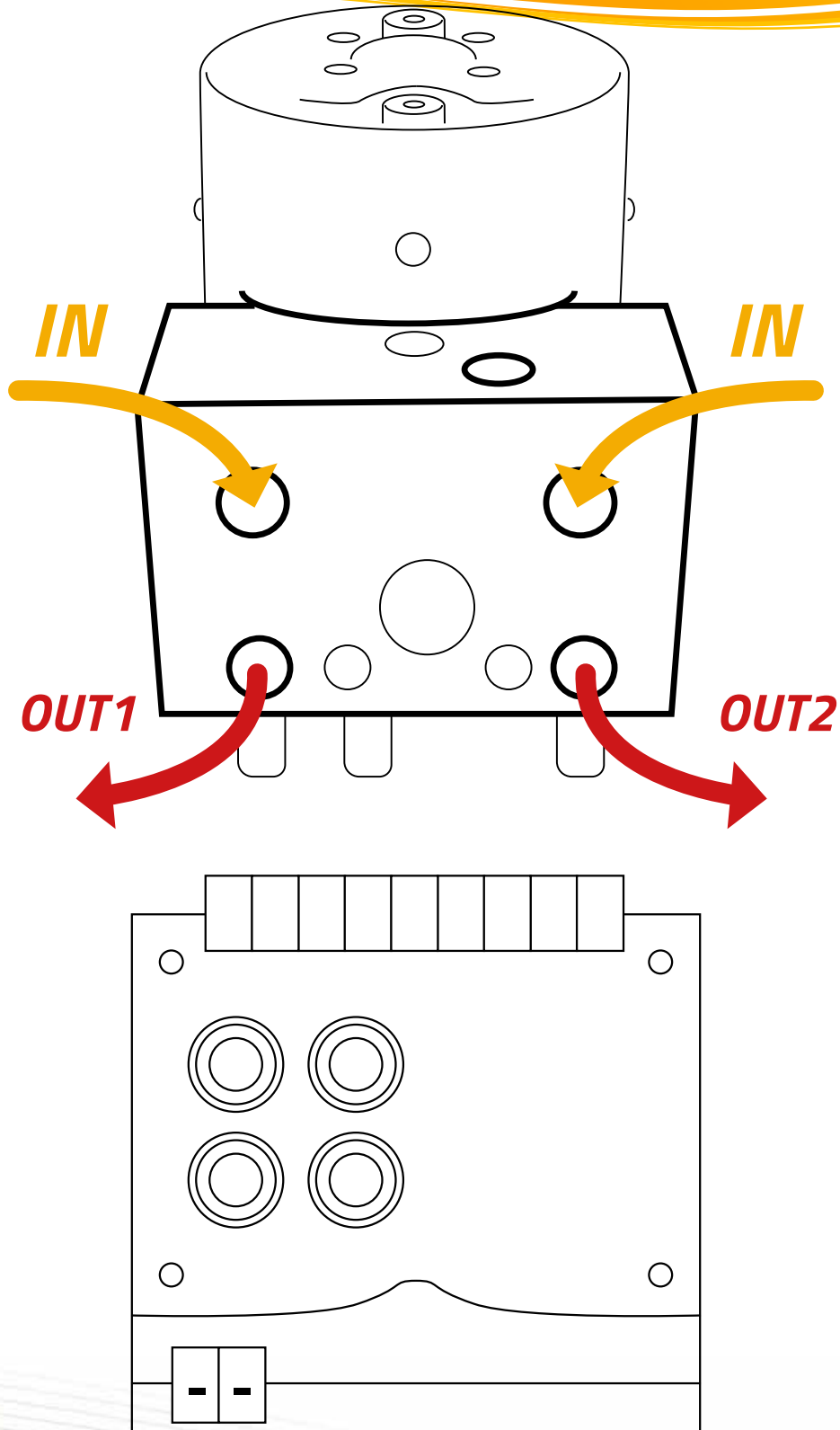

IN AGGIORNAMENTO